



# Research Report 2014/15

International Graduate School  
for Dynamics in Logistics

Volume 4 2015



# Content

<b>Dynamics in Logistics</b>	2
<b>Research Beyond Boundaries</b>	4
<b>International Doctoral Training in Logistics</b>	6
<b>Achievements and Guests</b>	8
<b>Alumni</b>	10
Larbi Abdenebaoui	
<b>Graph-transformational Swarms</b>	11
Samaneh Beheshti-Kashi	
<b>Fashion Forecasting in Social Media: A Qualitative Comparison of Relevant Channels</b>	15
Elham Behmanesh	
<b>A Flexible Integrated forward/reverse Logistics Model Using Metaheuristic Algorithms</b>	19
Morice Daudi	
<b>Trust Dynamics in Early Phases of Supply Chain Collaboration</b>	21
Arighna Deb	
<b>Optimization Techniques for Reversible Circuit</b>	25
Nagham El-Berishy	
<b>A Green Logistics Oriented Framework for Integrated Production-Distribution under Uncertainty in the Batch Processes Industry</b>	27
Christoph Greulich	
<b>Decentralized Resource Allocation for In-House Logistics</b>	34
Kishwer Abdul Khaliq	
<b>IEEE 802.11p MAC Protocol Extension to Support Bandwidth Hungry Applications</b>	39
Arshia Khan	
<b>Model Development: For Analyzing Major Strategies and Issues of Supply Chain under Mass Customization</b>	43
Yasir Mehmood	
<b>Enhancements for M2M Communication in Future Mobile Networks</b>	46
Elahah Gholamzadeh Nabati	
<b>Enhancing the Product Life Cycle Information Feedbacks</b>	51
Thomas Pötsch	
<b>Massive M2M Communication in LTE Networks</b>	55
Himangshu Sarma	
<b>From Textual Instructions to Virtual Actions – A Case Study</b>	59
Muhammed Waseem Tahir	
<b>Scope of Computer Vision Techniques for the Detection of Microbial</b>	61
Molin Wang	
<b>Commercialization Challenges for Electric Vehicles in Urban Logistics</b>	63
Nayyer Abbas Zaidi	
<b>An Idea of 3D Printed GC Column in Gas Chromatographic Systems</b>	67
Raúl Zuñiga Arriaza	
<b>Modeling the Processes of the Mining Industry Using SCOR and DCOR models</b>	69
<b>Imprint</b>	74



## Dynamics in Logistics

Logistics overcomes distances – and not only by routes of transportation. To guarantee smooth logistical flows in globally linked supply chains it is essential to perceive and consider diversity of cultures as well. Cultural differentiations mean specific disciplinary research conduct as well as social or religious differences which significantly influence the behaviour of people, their business practices, their specific ways of using technology or of executing research. Cultural background is a crucial factor in problem-solving processes and in international networks.

The Bremen Research Cluster for Dynamics in Logistics (*LogDynamics*) performs multi-disciplinary research in logistics. Working groups of four different faculties of the University of Bremen have cooperated in research and education for 20 years already. In the past decade, our *LogDynamics* team has put great emphasis on its international doctoral training programme as well. It conceptually designed the International Graduate School for Dynamics in Logistics (IGS) and successfully launched this programme. We are constantly working on its improvement by designing, evaluating and implementing new measures to structure and support the doctoral process in logistics, particularly in the engineering sciences. Cross-cultural cooperation on a regular basis over a prolonged period is how the IGS deepens cultural awareness.

The IGS has an excellent track record: 56 young scientists from 23 countries have started their PhD in this programme. 24 of them have already been awarded with a doctoral degree by the University of Bremen. Since 2015 all scholarships have been financed by third party funds. Moreover,

the German Academic Exchange Service (DAAD) as well as the Erasmus Mundus mobility projects *CLINK*, *FUSION* and *gLINK* contribute to the funding of scholarships and to the international recognition of the IGS programme. To prospectively strengthen and expand our network on a national level, we have started cooperating closely with the Graduate School of Logistics of Technical University of Dortmund.

The Research Report 2014/15 provides a kaleidoscope of research topics, results, training concepts and snapshots of the course of life in the IGS.

Dr.-Ing. Ingrid Rügge

*Managing Director  
International Graduate School  
for Dynamics in Logistics*

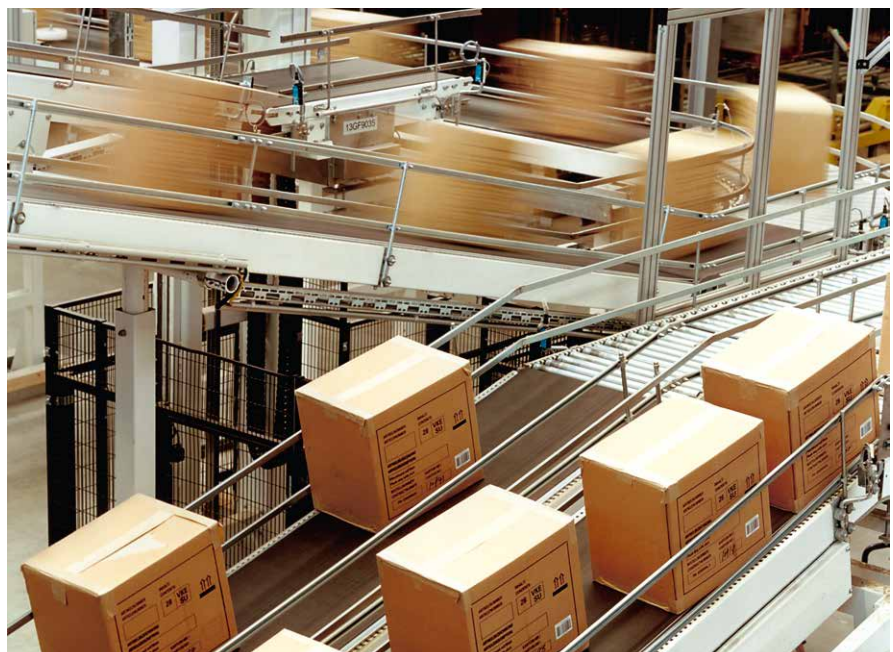



### Logistics in Bremen

The federal state of Bremen is the second largest logistics location in Germany. This is due to its advantageous maritime position and good hinterland network. Established logistic-related companies are based in Bremen, like for example aeronautics and space technology, automobile construction, food manufacturers, etc. The importance of the logistics industry for the state of Bremen implies the respective scientific focus.

The University of Bremen meets the demand for logistics research by linking competences of different scientific disciplines within an interdisciplinary high-profile area. The Bremen Research Cluster for Dynamics in Logistics (short: *LogDynamics*) was founded in 1995 as a cooperating network of research groups originated from four faculties: Physics/Electrical Engineering, Mathematics/Computer Science, Production Engineering and Business Studies/Economics. Recently the logistics focus has been acknowledged by contributing to the title "University of Excellence" awarded by the German Research Foundation (DFG). Besides the four faculties, further partners within *LogDynamics* are: BIBA – Bremer Institut für Produktion und Logistik GmbH, ISL – The Institute of Shipping Economics and Logistics (ISL), and the Jacobs University Bremen gGmbH.

The activity fields of *LogDynamics* range from fundamental and applied research to transferring findings into practice. The research cluster collaborates closely with enterprises. The objective is to strengthen interdisciplinary research and development

in the competence area of logistics for the benefit of the region Bremen as well as to foster international cooperation.

The International Graduate School for Dynamics in Logistics (IGS) is the structured doctoral training programme of *LogDynamics*. It offers outstanding researchers from all around the world the opportunity to complete a doctorate at a logistics location of long standing tradition. The objective of the IGS is to foster excellence in research and education by pursuing an interdisciplinary and cross-cultural approach.

### Interdisciplinary Cooperation

Most of today's logistic challenges cannot be solved within one single scientific discipline. Therefore, research in *LogDynamics* is based on interdisciplinary cooperation to generate synergy effects. The research cluster conducts fundamental and applied research, offers education at the highest level and organises scientific conferences. At the same time the reference to industrial practice is one of the most important aspects.

*LogDynamics* makes special efforts to feature opportunities for cooperation between science and industry. Furthermore, it promotes the idea of giving small and middle-sized enterprises access to research and innovation. The resulting dialogue of industry and science contributes to a better understanding of different perspectives and possible solutions in logistics.

### Doctoral Training

The aim of the IGS is to identify, to describe, to model and to evaluate the required and feasible intrinsic dynamics in logistics processes and networks both on an operational as well as on a strategic level. It conducts research on innovative dynamic planning and control by using new decision support algorithms and methods, new communication and cooperation arrangements as well as new technologies. Special topics are adaptive and dynamic control methods for logistics as well as the synchronisation of material and information flows. Against this background, cross-disciplinary cooperation under consideration of intercultural aspects is the basis for research.

The IGS meets the challenge of globalisation through practice-oriented research within the scope of fundamental and applied research. The research is centred on four topic areas:

- Business models, decision processes and economic analyses of dynamics in logistics
- Holistic interdisciplinary methods for modelling, analysis and simulation of dynamics in logistics
- Adaptive and dynamic control methods in logistics
- Synchronisation of material, information, decision and financial flows

The curriculum includes individual doctorate projects, disciplinary supervision, scientific mentoring as well as specific training in the field of complementary skills.

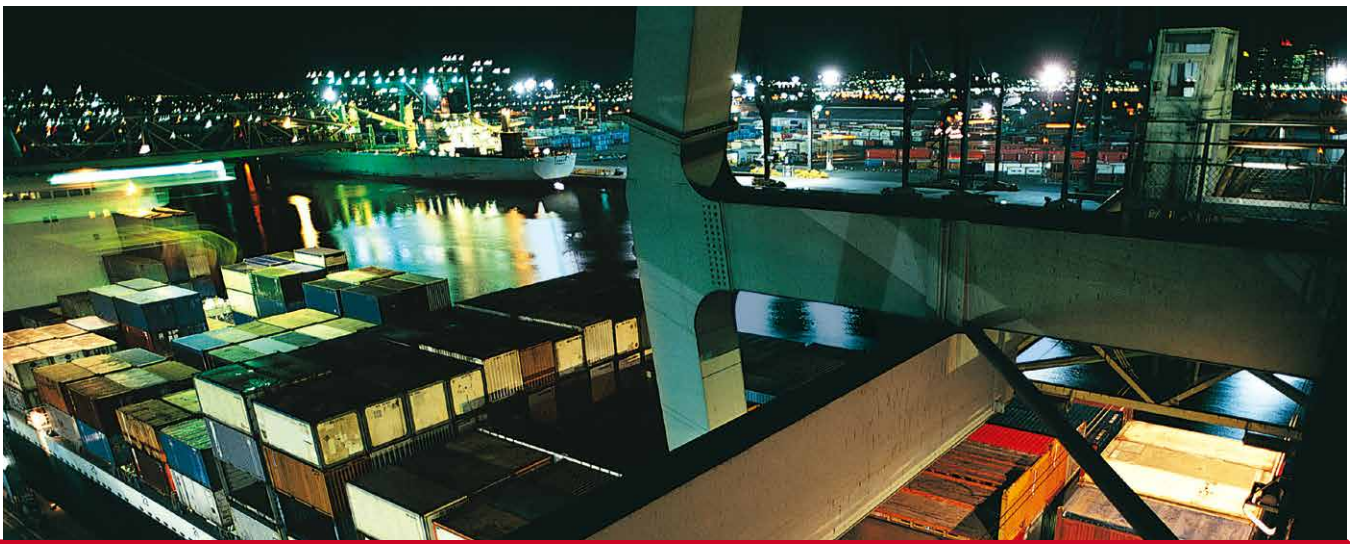

# Research Beyond Boundaries

## Faculty 1: Physics / Electrical and Information Engineering

Dynamics in Logistics is intrinsically tied to the information exchange of all players in the logistics domain: e.g. suppliers, manufacturers, transport companies, customs authorities. This information exchange is based on an increasing number of fixed and wireless information networks. Access networks usually employ wireless or mobile network technology directly or indirectly connected to infrastructure networks.

These networks range from sensor networks to satellite networks. Research topics in this area are related to the performance evaluation and optimization of communication processes. Another related aspect investigated is the use of information networks to implement dynamic routing algorithms for transport logistics. These react to dynamic events that, sometimes drastically, influence transport processes. Head of the research group Communication Networks is **Prof. Dr.-Ing. Carmelita Görg**.

In the near future it will be possible to capture not only the position of each container world-wide, but of any pallet or even each individual piece of goods. The conditions of carriage like temperature or humidity have to be supervised permanently and influence current decisions. Due to the high amount of resulting data a central control will not be possible. Especially during periods of missing radio communication the freight has to react on disturbances and new information correctly. With new mathematical theories and progresses in microelectronics and micro system technologies, it will be possible to integrate low-cost sensors to monitor and control the product quality as well as the

environmental parameters. This contains the conception of the ad-hoc sensor network and the communication system. New sensors and wireless communication mechanisms have been investigated under the notion of "Intelligent Container". **Prof. Dr.-Ing. Walter Lang** is director of the Institute for Microsensors, -actuators and -systems (IMSAS).

## Faculty 3: Mathematics / Computer-Science

In the logistics scenarios of the future, intelligent autonomous robots will automate warehouses and logistics centers by fetching, placing, and rearranging products. Further, they will automate the supply chains for the production and transportation of goods. **Prof. Michael Beetz Ph.D.** is head of the Institute for Artificial Intelligence. His research interests include plan-based control of robotic agents, knowledge processing and representation for robots, integrated robot learning, and cognitive perception.

Circuits and systems were mainly applied in computers a few years ago. Meanwhile they are part of everyday life and are used more and more in safety-critical areas. They are the core technology in Cyber-Physical Systems (CPS). CPS play a key role in overcoming logistical challenges, and they contribute to finding solutions for the increasing complexity in the logistic sector. **Prof. Dr. Rolf Drechsler** represents the subject of computer architecture in research and teaching. His research interests comprise the complete design flow of circuit and system, where he especially focuses on testing and verification using formal techniques. Since 2011, he is

a director in the German Research Center for Artificial Intelligence (DFKI) in Bremen, where he also leads the research group of Cyber-Physical Systems.

In analogy to conventional logistics, autonomous logistic processes are in need of knowledge to perform their task. Data, information, and knowledge are the key resources which ensure the quality of the logistic process. Knowledge management is required to support autonomous logistic processes by providing context-sensitive information. Furthermore it has to be considered that actors in these processes act in a competitive way. Consequently, information and knowledge should be treated as tradable goods which have a high utility potential for their consumers. Projects by **Prof. Dr.-Ing. Otthein Herzog** include, for example, knowledge management for the planning and scheduling of autonomous logistic processes.

In software engineering as well as in other areas of computer science diagrams and graphs are used in manifold ways for modelling logistic processes, easily describing and visualizing complex structures. Rule-based methods have proven to be extremely effective for capturing dynamic aspects like process and system flow. This inspires the attempt to employ rule-based graph transformation for modelling logistic processes and systems. Since the so-called graph transformation units in particular include a control component, they are an obvious choice for the description of autonomous logistic processes. **Prof. Dr.-Ing. Hans-Jörg Kreowski** is professor for theoretical computer science and member of the TZI (Centre for Computing and Communication Technologies).

IT is moving into living and work areas where it has not previously been possible to provide support to people on the move.

**Prof. Dr. Michael Lawo** is professor for applied computer science and is involved in numerous projects of logistics, wearable computing, artificial intelligence and IT-security. In his research he deals mainly with human-computer-interaction for industrial as healthcare applications or even human-robot-collaboration.

Logistic Processes are always linked to humans who can play multiple roles. Humans are at the one end of the process customers or consumers. At the other end, they manage and control processes and in the middle they can work as drivers, packers or in a variety of different jobs. Modelling the semantics of logistic processes and interaction in and with logistic processes is an important subject in logistics and human computer interaction. **Prof. Dr. Rainer Malaka** is Professor for Digital Media and director of the TZI (Centre for Computing and Communication Technologies). The focus of his work is intelligent interactive systems and his projects include interactive systems, contextual computing, multimodal interaction, semantics and ontologies, adaptive and cognitive system.

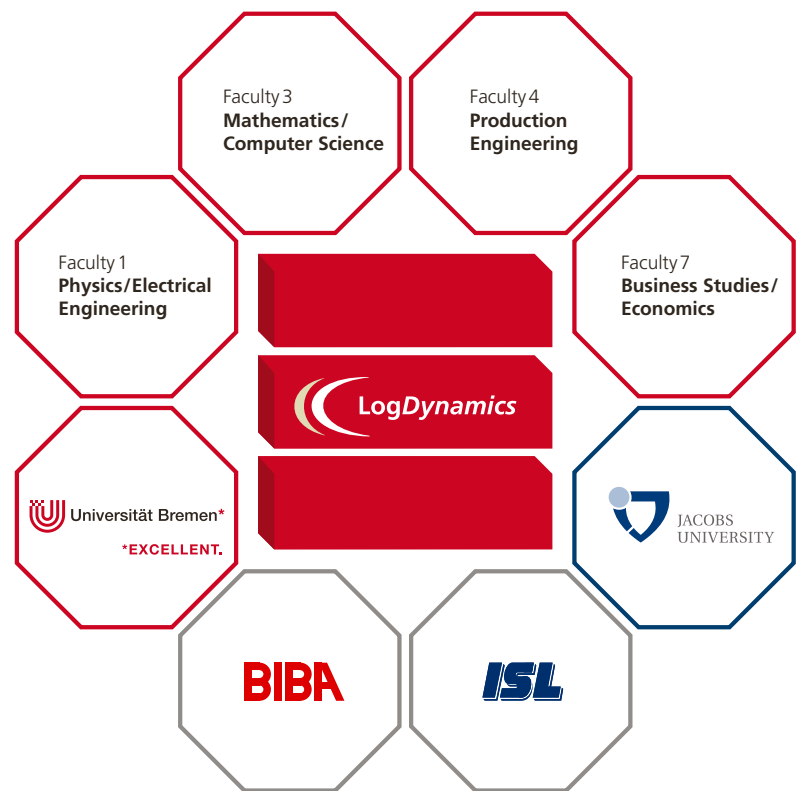

#### Faculty 4: Production Engineering

The dynamics of logistic networks and processes is growing in today's globalised world. This implies new technical and structural challenges to design and steer such systems. **Prof. Dr. Jürgen Pannek** is professor for Dynamics in Logistics, a subject which combines engineering science, informatics, mathematics and science of management. His research focus lies on the development of methods for modeling, simulation and control of logistic systems regarding dynamics and complexity on operational, tactical and strategic level. Instead of compensating for the dynamics, his goal is to integrate and utilise it within the control of the production and logistic system.

High performing co-operations between independent companies with the aim to develop and realise customised products are an important success factor for the competitiveness of the European industry. So called enterprise networks can be seen in addition to the traditional supply chains. The research unit "ICT applications for production" prepares, develops, and realises methods and tools to support co-operative inter-organisational enterprise networks. The research concentrates on

efficient and effective collaborative design and production processes by applying innovative information and communication technologies (ICT). As focus can be seen the collaborative acting of enterprises during distributed design and production processes as well as during the late processes of the product life cycle such as the usage phase or the recycling phase. **Prof. Dr.-Ing. Klaus-Dieter Thoben** is director of this research unit. Since September 2012 he is managing director of BIBA – Bremer Institut für Produktion und Logistik GmbH and spokesman of LogDynamics.

The increasing complexity of production systems and logistic networks requires the development, use, and integration of new methods of planning and control. The research aims at developing and applying new concepts, methods, and ICT solutions in logistic processes. This pursues the goal of a sustained optimisation of production and logistic systems. Until August 2012 **Prof. Dr.-Ing. Bernd Scholz-Reiter** was managing director of the BIBA, head of the department "Planning and Control of Production Systems" as well as spokesman of LogDynamics and IGS. Now he is engaged in his new function as rector of the University of Bremen.

#### Faculty 7: Business Studies / Economics

Logistics research in mobility and elaboration of tools which are made for the development and evaluation of an added value orientated system integration of intermodal transport already pick up today's major design options for the realization of sustainable economics. **Prof. Dr rer. pol. Hans-Dietrich Haasis** holds a chair in general business studies, production management and industrial management. He is managing director of the Institute of Shipping Economics and Logistics (ISL), head of the logistic systems unit and from July 2012 on spokesman of the IGS. Advisory service and research of this unit are focused on cooperative systems in and between logistics and production as well as solutions for regions and hubs as well as business concepts form enterprises. These topics also integrate an e-business orientated management of supply chains in relationship to partially conflicting objectives of business operations and transportation.



# International Doctoral Training in Logistics

## International Doctoral Training in Logistics

Since 2005 the International Graduate School for Dynamics in Logistics (IGS) at the University of Bremen has been offering excellent researchers from all around the world the opportunity to complete an efficient, structured graduate training at a logistics location with a long-standing tradition. The IGS is embedded in the Bremen Research Cluster for Dynamics in Logistics (*LogDynamics*) and collaborates closely with commercial enterprises. The curriculum of the IGS is designed for a three-year full time doctoral study. It bundles interdisciplinary competences and cross-cultural cooperation and fosters the link between research and industry. Besides the individual doctoral project the curriculum covers collective thematic introductions, subject specific courses, interdisciplinary colloquia, dialogue forums, excursions, as well as individual coaching regarding complementary skills and personality development. The language of training and thesis is English. However, a basic knowledge of the German language and culture is also required. German IGS graduates have the opportunity to participate in a scientific exchange at foreign universities. All these elements involve the young researchers in a critical dialogue which – instead of presenting a single dominant perspective – encourages discussions beyond scientific boundaries and helps to create a dynamic, issue-related network. A system of concerted-individual

measures ensures the well-directed and effective personnel development through the institutional combination of possibilities and obligation to actively exchange ideas. This enables the doctoral candidates of the IGS to receive excellent qualifications and helps the university to gain efficient new insights. Furthermore, the IGS contributes to the transfer of the research results into practice.

### Structure of Doctoral Training

Eleven professors from four faculties of the University of Bremen are available as supervisors or as mentors for the doctoral candidates at the IGS. Additionally, the early stage researchers receive a structural supervision from the Managing Director of the IGS and scientific support from the postdoctoral research fellows in their working groups.

### Doctoral Project

Working on the doctoral project is the central research activity in the curriculum. In order to fulfil this work under optimal conditions the doctoral candidates are integrated in the disciplinary research group of their supervisors. Through this disciplinary assignment they can benefit from the knowledge and the infrastructure of the respective faculty and institute. Furthermore, they learn to use the tools of scientific work which are required for their particular project and receive individual support in their research activities.

## Courses and Coaching

Courses are divided into lectures with tutorials, seminars, workshops, practical training, and integrated learning in small groups and individual coaching. The aim of the disciplinary courses is to educate on the level of international standards of the respective research area. Thematic introductions into the “other” disciplines support the interdisciplinary cooperation at the IGS. Additional course-offers include project management, research process and methods, academic writing, presentation and communication techniques, cross-cultural co-operation, language courses, and voice development.

### Interdisciplinary Research Colloquium

The interdisciplinary research colloquium offers an institutional and issue-related forum to present and discuss the concept and status of the doctorate projects with the whole faculty. The young researchers have the opportunity to exchange research results, develop interdisciplinary research questions, and participate in cross-disciplinary discussion groups. Colloquia with lecturers of *LogDynamics* or visiting professors ensure targeted impulses for the individual research projects.





### **LDIC – Doctoral Workshop**

The LDIC – Doctoral Workshop is organised as a part of the International Conference on Dynamics in Logistics (LDIC), in a biennial conference set up by LogDynamics. The workshop addresses PhD students in an early stage of their PhD project. It offers an opportunity to present and to defend the own research topic, the first ideas for a research approach and the first findings. The purpose is to generate impact for the progress and the excellence of the thesis by discussing and reviewing the research proposals and to present the own research in an international context. Thus, a second integral aspect of the Doctoral Workshop is the training of professional presentation skills for science and academia.

### **LogDynamics Summer School**

The LogDynamics Summer School (LOGISS), organised by LogDynamics, strives to generate a network of young researchers within the field of logistics. The aim of the network is to foster ideas from the various discipline and give rise to opportunities for joint research. To support this process, besides offering intensive tutorial lectures delivered by international lecturers from renowned universities, the Summer School is accompanied by classical social elements such as get-together, dinner and guided tour, but also comprises new features such as research speed dating for scientific purpose and group lab sessions.



## Achievements and Guests

LogDynamics contributed to the success story of the University of Bremen in the high-profile area logistics. The University of Bremen succeeded in the national competition of the Excellence Initiative. The IGS is the educational part of LogDynamics and contributed particularly by its very high degree of internationality and interdisciplinary of research and education.

The IGS is partner of three Erasmus Mundus mobility projects, funded by the European Commissions:

- cLINK – Centre of Excellence for Learning, Innovation, Networking and Knowledge

The project facilitates the academic exchange between European and Asian universities.

- FUSION – Featured eEurope and South Asia mObility Network

The project aims to foster partnerships of emerging Asian with European countries to enhance the capacity for international cooperation by facilitating transfer of people, know-how, culture and best practice in training the next generation of researchers and academic staff.

- gLINK - Sustainable Green Economies through Learning, Innovation, Networking and Knowledge Exchange

The project aims to promote multi-disciplinary advanced research, education and professional training on sustainable green solutions through mutual collaboration and knowledge exchange between Europe and Asia.

Through these projects, scholarships on all academic levels, such as Bachelor, Master students, doctoral candidates, Postdoctoral researchers, academic and administrative staff, are offered for a mobility from Asia to Europe or vice versa. Since 2013, already more than 30 students and researchers, have been mobilised from Asia to Bremen, and this has improved the cooperation across wide distances. One example:



The FUSION project and the mobility of Lucy Schott, a student of Production Engineering at the University of Bremen, to Zhongyuan University of Technology (ZUT) in China induced the mobility of two doctoral candidates to the IGS and a

signing cooperation agreement to intensify the exchange.

By integrating students from Asia into the academic training programme, the IGS extends and intensifies its international foundation through personal experiences. In this way the alumni, the guest researchers and the cLINK, FUSION, and gLINK fellows are ambassadors of LogDynamics and the high quality of education and research within the IGS.

To extend the supervision capacities for the doctoral students of the IGS, LogDynamics established a new position of a junior professorship on Dynamics in Logistics. The doctoral candidates will benefit from the Excellence Initiative as well, since two further professorships will be implemented which bridge the gap between the University of Bremen and the external research institutes ISL – Institute of Shipping Economics and Logistics and BIBA – Bremer Institut für Produktion und Logistik GmbH. Additionally, the leadership of young research groups received funding.

Alumni of the IGS are working contributed over the world. Some stay in Germany and contribute as guest lecturers to the curriculum of the IGS. Others went back to their home countries or are now Postdocs in other countries. They are sending new outstanding doctoral candidates to Bremen. We love this lively cooperation and exchange between scientific disciplines, cultures and continents!

## Visiting Scientists

**Prof. Dr. Mujtaba Hassan Agha**

cLINK fellow, TT of Production Engineering  
Mohammed Ali Jinnah University, Islamabad, Pakistan

**Mohammad Ali**

FUSION fellow of Engineering and Technology  
United International University, Bangladesh

**B.M. Ruhul Amin**

cLINK fellow of Electrical and Electronic Engineering  
Islamic University of Technology, Bangladesh

**Feroj Bepari**

cLINK fellow of Computer Science  
United International University, Bangladesh

**Dr. Lintao Duan**

FUSION fellow, PostDoc of Engineering and Technology  
School of Information Science and Technology, Chengdu  
University, China

**Sundari Enkhutugs**

gLINK fellow of Management and Production Engineering  
National University of Mongolia

**Juliana Fisaini**

gLINK fellow of Management and Production Engineering  
Institut Teknologi Bandung, Indonesia

**Prof. Dr.-Ing. Enzo Morosini Frazzon**

Department of Production Engineering  
Federal University of Santa Catarina (UFSC), Brazil

**Dorjsundui Gombokhurts**

gLINK fellow of Management and Production Engineering  
National University of Mongolia

**Debkalpa Goswami**

cLINK fellow of Production Engineering and Computer Science  
Jadavpur University, Kolkata, India

**Prof. Hamid Reza Karimi, PhD**

Faculty of Engineering and Science,  
University of Agder, Grimstad, Norway

**Dr. Shree Ram Khadka**

cLINK fellow, PostDoc of Production Engineering  
Tribhuvan University, Kathmandu, Nepal

**Dr. Azfar Khalid**

cLINK fellow, PostDoc of Production Engineering  
Mohammed Ali Jinnah University, Pakistan

**Dr. Asela Kulatunga**

gLINK fellow, PostDoc of Engineering and Economics University of  
Peradeniya, Sri Lanka

**Natcha Kurupakorn**

cLINK fellow of Management and Production Engineering  
Chiang Mai University, Thailand

**Chao Liu**

FUSION fellow of Engineering and Technology  
School of Information Science and Technology, Chengdu  
University, China

**Prof. Dr. Elvis de Azevedo Matos**

Universidade Federal do Ceará (UFC), Ministério da Educação, Insti-  
tuto de Cultura e Arte, Fortaleza, Ceará, Brazil

**G. M. Monjur Morshed Mridha**

cLINK fellow, TT of Production Engineering  
United International University, Dhaka, Bangladesh

**Ugyen Nima**

FUSION fellow of Engineering and Technology  
College of Science and Technology, Royal University of Bhutan

**Dr. Nicole Pfeffermann**

Pfeffermann Strategy Consulting, Köln, Germany

**Nimra Rehman Siddiqui**

FUSION fellow of Engineering and Technology von der Mehran  
University of Engineering & Technology, Pakistan

**Tshewang Rinzin**

cLINK fellow of Computer Science and Production Engineering  
College of Science and Technology, Royal University of Bhutan

**Phinthip Samutloiwon**

FUSION fellow of Engineering and Technology  
Chiang Mai University, Thailand

**Prof. Dr. Erwin Schrader**

Universidade Federal do Ceará (UFC), Ministério da Educação,  
Instituto de Cultura e Arte, Fortaleza, Ceará, Brazil

**Prof. Parashuram Sharma**

cLINK fellow, TT of Engineering and Technology  
Jigme Namgyel Polytechnic, Royal University of Bhutan

**Prof. Dr. Habiburrahman Shirani**

FUSION fellow, TT in Electrical Engineering, Kabul University,  
Afghanistan

**Supattra Tasuya**

cLINK fellow of Management and Production Engineering  
Chiang Mai University, Thailand

**Boondhrikaan Vaidyanuvatti**

cLINK fellow of Business Economics and Computer Science  
University of Chiang Mai, Thailand

**Rinzin Wangdi**

cLINK fellow of Management and Production Engineering  
College of Science and Technology, Royal University of Bhutan

**Wei Wei**

cLINK fellow of Engineering and Management  
Dalian Maritime University, China

**Zifeng Yi**

cLINK fellow of Engineering and Management  
Dalian Maritime University, China

**Nima Zangmo**

cLINK fellow of Management and Production Engineering  
College of Science and Technology, Royal University of Bhutan

# Alumni



## Alumni of the International Graduate School for Dynamics in Logistics

**Dr.-Ing. Ali Badar Mohamed Alamin Dow, M.Sc.**

*Physics / Electrical and Information Engineering*  
Design and Fabrication of a Micromachining Preconcentrator  
Focuser for Ethylene Gas Detection System

**Dr.-Ing. Mehرداد Babazadeh, M.Sc.**

*Physics / Electrical and Information Engineering*  
Plausibility Check and Energy Management in a Semi-autonomous  
Sensor Network Using a Model-based Approach

**Dr.-Ing. Jan Ole Berndt, Dipl. Inf.**

*Mathematics / Computer Science*  
Self-organizing Supply Networks: Emergent Agent Coordination  
in Autonomous Logistics

**Dr.-Ing. Kateryna Daschkovska, Dipl.-Ing., M.Sc.**

*Production Engineering*  
Electronic Seals and their Influence on the Dynamics of Container  
Logistics

**Dr.-Ing. Salima Delhoum, M.S.I.E.**

*Production Engineering*  
Evaluation of the Impact of Learning Labs on Inventory Control –  
An Experimental Approach with a Collaborative Simulation of a  
Production Network

**Dr.-Ing. Enzo Morosini Frazzon, MB**

*Production Engineering*  
Sustainability and Effectiveness in Global Logistic Systems – An  
Approach Based on a Long-Term Learning Process

**Dr.-Ing. Fasika Bete Georgise, M.Sc.**

*Production Engineering*  
Supply Chain Modeling & Improvement of Manufacturing Industry  
in Developing Countries

**Dr. rer. pol. Julie Gould, M.A.**

*Business Studies / Economics*  
A Decision Support System for Intermodal Logistics under Considerations for Costs of Safety and Security

**Dr.-Ing. Safir Issa, M.Sc.**

*Physics / Electrical Engineering*  
Flow Sensors and their Applications to convective Transport in the  
Intelligent Container

**Dr.-Ing. Amir Sheikh Jabbari, M.Sc.**

*Physics / Electrical and Information Engineering*  
Autonomous Fault Detection and Isolation in Measurement Systems

**Dr.-Ing. Amir Jafari, M.Sc.**

*Physics / Electrical and Information Engineering*  
Development and Evaluation of an Autonomous Wireless Sensor  
Actuator Network in Logistic Systems

**Dr.-Ing. Huaxin Liu, M.Sc.**

*Production Engineering*  
A Dynamic Bottleneck-oriented Manufacturing Control System

**Dr.-Ing. Safdar Marwat, M.Sc.**

*Physics / Electrical and Information Engineering*  
Link Level Scheduling for Future Mobile Communication

**Dr.-Ing. Afshin Mehrsai, M.Sc.**

*Production Engineering*  
Feasibility of Autonomous Logistic Processes by Reconfiguration of  
Business Processes

**Dr.-Ing. Javier Palafox, M.Sc.**

*Physics / Electrical Engineering*  
Analysis and Prediction of Sensor and Quality Data in Food  
Transport Supervision

**Dr.-Ing. Nicole Pfeffermann, Dipl.-Ök.**

*Production Engineering*  
An Integrated Management Concept of Innovation Communication  
and its Contribution to Company Value

**Dr.-Ing. Mehdi Safaei, M.Sc.**

*Production Engineering*  
Delivery Time Uncertainty in Dynamic Supply Networks

**Dr.-Ing. Arne Schuldt, Dipl. Inf.**

*Mathematics / Computer Science*  
Multiagent Coordination Enabling Autonomous Logistics

**Dr.-Ing. Gulshanara Singh, M.Sc.**

*Physics / Electrical and Information Engineering*  
Efficient Communication in Agent-based Autonomous Logistics  
Processes

**Dr.-Ing. César Stoll, M.L.I.**

*Production Engineering*  
Evaluation of the Application of Automatic Conditions Monitoring  
of Produce in Fresh Food Warehouses

**Dr.-Ing. Vo Que Son, M.Eng.**

*Physics / Electrical and Information Engineering*  
Modeling and Implementation of Wireless Sensor Networks for  
Logistic Applications

**Dr. rer. pol. Jiani Wu, M.A. in Management**

*Business Studies / Economics*  
Sustainable Freight Village Concepts for Agricultural Products  
Logistics

**Dr. rer. pol. Hongyan Zhang, M.A. in Management**

*Business Studies / Economics*  
Knowledge Integrated Business Process Management for Third  
Party Logistics Companies

**Dr.-Ing. Raúl Zuñiga Arriaza, M.Sc.**

*Production Engineering*  
Modeling of Supply Chain Processes of the Mineral Raw Materials  
Industry from the Perspective of EM, SCOR and DCOR Models

# Graph-transformational Swarms

Larbi Abdenebaoui

The concept of graph-transformational swarms is a novel approach that offers a rule-based framework to model discrete swarm methods. It is flexible enough to cover various existing notions of swarms and swarm computation, and it provides a mathematical basis for the analysis of swarms with respect to their correct behavior and efficiency. This paper recalls the main ideas behind the concept. It gives an illustrative example of a simple ant colony that finds shortest paths in a linear number of steps with high probability.

**Introduction >>>** Swarms in the nature are fascinating phenomena that have inspired various concepts and algorithms in computer science (see, e.g., [3, 4]). However, there seems to be no framework unifying those concepts. Graph-transformational swarms have been proposed in [1], to partly fill this gap by providing a framework to model a variety of discrete swarm methods. In [1], cellular automata and discrete particle systems are modeled to demonstrate the usefulness and flexibility of the approach. This paper recalls the main ideas of Graph-transformational swarms. An example of a simple ant colony illustrates the concept. <<<

## Basic concepts of graph transformation

In this section, we recall the basic components of the chosen graph transformation approach as far as needed in this paper (for more details, see, e.g. [2, 6, 7, 8]).

A (*directed edge-labeled*) **graph** consists of a set of unlabeled nodes and a set of labeled or unlabeled edges such that every edge is directed. If the target is equal to the source, then the edge is called a *loop*. A *match* of a graph  $G$  in a graph  $H$  is an image of  $G$  in  $H$  under a graph morphism.

A **rule**  $r = (L, K, R)$  consists of three graphs, the *left-hand side*  $L$ , the *gluing graph*  $K$ , and the *right-hand side*  $R$ .  $K$  is a subset of  $L$  and  $R$ . The graphs  $L, K$  and  $R$  are called the rule components. Fig. 1 shows the rule *wakeup* which is used later in the *simple ant colony* example.

Figure 1: A graph transformation rule

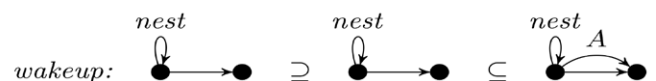

Given two rules  $r_1$  and  $r_2$ , the *parallel rule*  $p = r_1 + r_2$  is a rule given by the disjoint unions of the respective components. The parallel rule definition still holds for an arbitrary number of rules.

The **application of a rule**  $r = (L, K, R)$  to a graph  $G$  replaces a match of  $L$  in  $G$  by  $R$  such that the match of  $K$  is kept. Fig. 2 illustrates the application of the rule *wakeup*. As in Fig. 2, derivations are generally denoted with an arrow labeled with the name of the applied rule.

Figure 2: A rule application

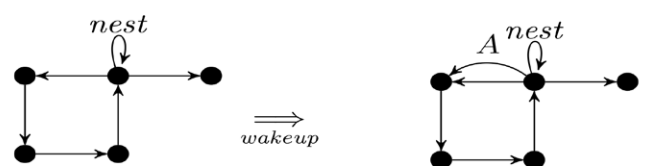

## Theorem 1. Parallelization theorem [5]

A parallel rule  $p$  can be applied to  $G$ , if and only if the rules, which build  $p$ , can be applied to  $G$  and the matches are pairwise independent. Moreover, those rules can be applied one after the other in arbitrary order, deriving in each case the same graph as the application of  $p$  to  $G$ .

According to the Parallelization theorem, the rule components of  $found + found$  in Fig. 3 can be applied separately to the left graph and are parallel independent. Conversely, these two parallel independent applications of  $found$  can be executed in parallel.

Figure 3: Two parallel independent rules and their parallelization

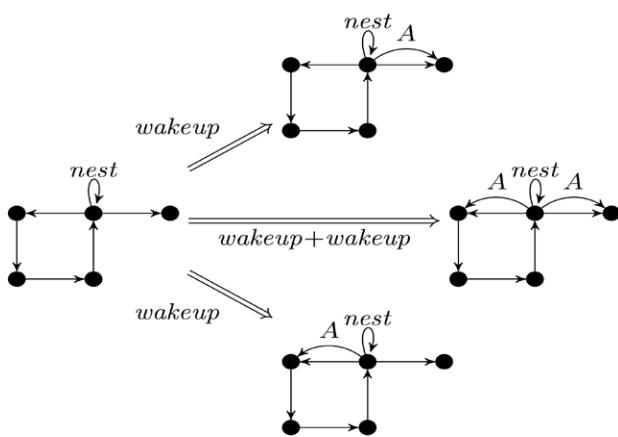

A **control condition**  $C$  is defined over a finite set  $P$  of rules and specifies a set  $SEM(C)$  of derivations. Typical control conditions are priorities and regular expressions over  $P$ .

A **graph class expression**  $X$  specifies a set of graphs denoted by  $SEM(X)$ .

A **graph transformation unit** is a pair  $gtu = (P, C)$ , where  $P$  is a set of rules, and  $C$  is a control condition over  $P$ . The semantics of  $gtu$  consists of all derivations of the rules in  $P$  allowed by  $C$ . A unit  $gtu$  is related to a unit  $gtu_0$ , if  $gtu$  is obtained from  $gtu_0$  by relabeling. The set of units related to  $gtu_0$  is denoted by  $RU(gt u_0)$ .

## Graph-transformational swarms

A graph-transformational swarm consists of members of the same kind or of different kinds to distinguish between different roles members can play. All members act simultaneously in a common environment represented by a graph. The number of members of each kind is given by the size of the kind. While a kind is a graph transformation unit, the members of this kind are modeled as units related to the kind so that all members of some kind are alike.

A swarm computation starts with an initial environment and consists of iterated rule applications requiring massive parallelism, meaning that each member of the swarm applies one of its rules in every step. The choice of rules depends on their applicability and the control conditions of the members. We allow to provide

a swarm with a cooperation condition. Moreover, a swarm may have a goal given by a graph class expression. A computation is considered to be successful if an environment is reached that meets the goal.

### Definition 1 (swarm)

A swarm is a system  $S = (in, K, size, M, coop, goal)$  where  $in$  is a graph class expression specifying the set of initial environments,  $K$  is a finite set of graph transformation units, called kinds,  $size$  associates a size  $size(k)$  with each kind  $k$  in  $K$ ,  $M$  associates to each kind  $k$  in  $K$  a family of  $size(k)$  members in  $RU(k)$ ,  $coop$  is a control condition called cooperation condition, and  $goal$  is a graph class expression specifying the goal.

A swarm may be represented schematically depicting the components initial, kinds, size, members, cooperation and goal, followed by their respective values.

### Definition 2 (swarm computation)

A swarm computation is a derivation starting with a graph in  $SEM(in)$ , and ending with a graph  $H$ . Every derivation step, consist of the application of a parallel rule where every member of the swarm participates by a rule such that  $coop$  and the respective control conditions are satisfied.

We assume that each member has the empty rule in addition to its other rules. The empty rule gets the lowest priority. In this way, each member can always act and is no longer able to terminate the computation of the swarm. In this context, the empty rule is called sleeping rule. It can always be applied, is always parallel independent with each other rule application, but does not produce any effect. Hence, there is no difference between the application of the empty rule and no application within a parallel step.

## Simple ant colony

In this section, we illustrate the notion of graph-transformational swarms in a very simple ant colony. We model a simple ant colony as the graph-transformational swarm in Fig. 4. The colony consists of some ants, all of the same kind. They act in directed graphs with some nest- and food-loops. Initially, an environment graph is simple and – ignoring the loops – unlabeled. All ants wake up simultaneously by accessing edges that exit nodes with nest-loops. Then they forage for food by walking through the graph passing one edge per step while each ant marks its individual path. If an ant reaches a node with a food-loop, it starts to return to its nest re-traveling along its own marked path while marking this path with the label food. This ant colony is successful, whenever a path from a food-node to a nest-node is created such that all edges of the path are labeled with food. Such a path may be called food-path. It can be shown that a shortest food-path is found by this ant colony with high probability in a linear number of steps, provided that the colony is large enough.

Figure 4: The swarm simple ant colony with the kind ant

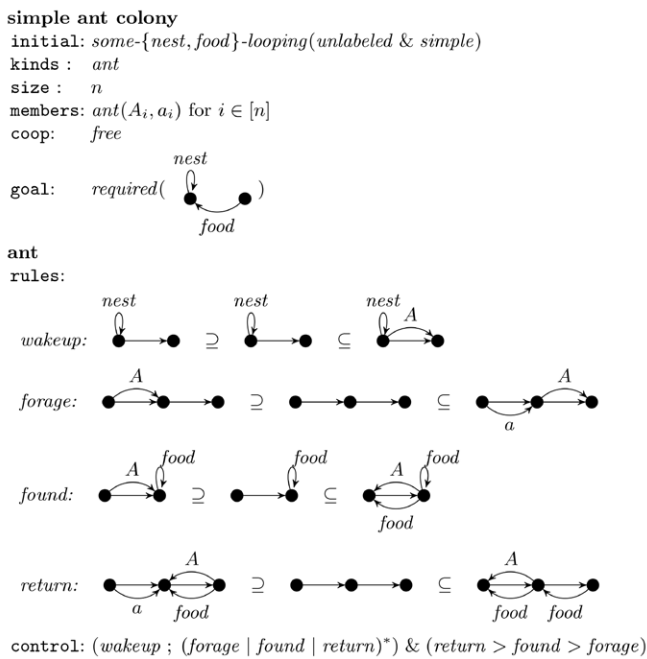

The members are obtained by relabeling *A* and *a* by using indices while all other labels are kept. The control condition requires that an ant wakes up in the beginning, but never again. Moreover, the application of the return-rule has higher priority than the *found*-rule, which in turn has higher priority than the *forage*-rule. Hence, the ant stops foraging whenever it finds food. From there on, it returns to the nest on the path labeled with a *food*-path because the return rule has the highest priority. This means for the computations of the ant colony that all ants wake up simultaneously in the first step. The respective rule applications are parallel independent because nothing is removed. If other rules are applied in later steps, then only edges with individual having the same index are removed so that each two ants can act in parallel as their rule applications are parallel independent.

To see what this ant colony can achieve, let *p* be a simple shortest path from a *nest*-node to a *food*-node, in some finite initial environment graphs, and let *q* be its length. Consider a computation of the swarm with at least  $2q$  steps. Then each ant runs along a path of length *q* in the first *q* steps, provided that it does not end up earlier in a node without outgoing edges. As the number of paths of length *q* (or shorter) is finite, the path *p* is among the traveled paths with some probability that grows with the size of the swarm. Hence, there is a good chance that some ant can apply the *found*-rule in step  $q+1$ . This ant re-travels *p* and marks it as a *food*-path in the next  $q-1$  steps such that a shortest path is established in  $2q$  steps with high probability, i.e., in a number of steps linear, in the number of nodes of the initial environment, as *q* is always smaller than the number of nodes. More sophisticated specifications of ant colony optimization algorithms using graph transformation can be found in [10, 11].

A first version of simple ant colony has been implemented in the graph transformation tool GrGen.NET [12]. The resulting computation steps of an experiment with a swarm of 7 ants  $A_1, \dots, A_7$  are partially displayed in Figure 5, where the small *a*'s are omitted to allow a good visualization. Only the initial graph and the end graph are displayed in Figure 5.

### Conclusion

In this paper, we have recalled the concept of graph-transformational swarms. It can be applied to a wide range of problem domain. The key is to model the given problem as a graph.

We have presented a simple ant colony as an example. Its solution takes advantage of massive parallelism, can be visually represented and support correctness results. However, in order to prove the power of the concept, bigger and more difficult examples should be modeled in the future. In logistic specially, one can consider task scheduling problems, which are NP-hard problems in general and can profit from a combination of swarm heuristics and the massive parallelism in the proposed framework.

Figure 5: A sample computation of the 'simple ant colony swarm'?

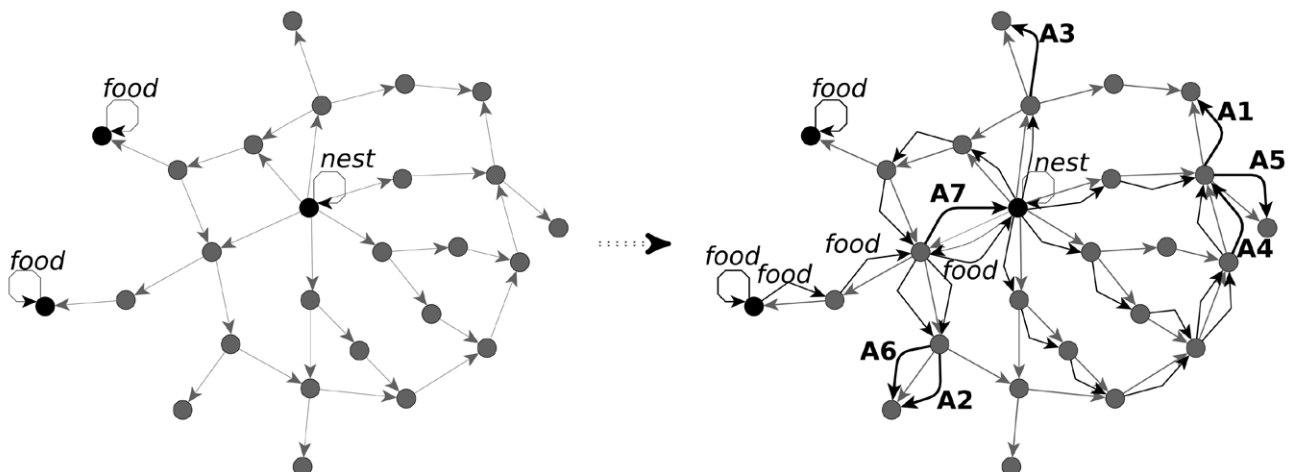

## References

- [1] Abdenebaoui, L.; Kreowski, H.-J.; Kuske, S.: Graph-transformational swarms. In: Bensch, S.; Drewes, F.; Freund, R.; Otto, F. (Eds.): *Fifth Workshop on Non-Classical Models for Automata and Applications – NCMA 2013*. Österreichische Computer Gesellschaft, 2013, pp 35–50.
- [2] Ehrig, H.; Ehrig, K.; Prange, U.; Taentzer, G.: *Fundamentals of Algebraic Graph Transformation (Monographs in Theoretical Computer Science. An EATCS Series)*. Springer, Berlin Heidelberg 2006.
- [3] Engelbrecht, A. P.: *Fundamentals of Computational Swarm Intelligence*. John Wiley & Sons, 2006.
- [4] Kennedy, J.; Eberhart, R. C.: *Swarm Intelligence. Evolutionary Computation Series*. Morgan Kaufman, San Francisco 2001.
- [5] Kreowski, H.-J.: *Manipulationen von Graphmanipulationen*. PhD thesis, Technische Universität Berlin 1977.
- [6] Kreowski, H.-J.; Klempien-Hinrichs, R.; Kuske, S.: Some essentials of graph transformation. In: Esik, Z.; Martin-Vide, C.; Mitrana, V. (Eds.): *Recent Advances in Formal Languages and Applications, volume 25 of Studies in Computational Intelligence*. Springer, Berlin Heidelberg 2006, pp 229–254.
- [7] Kreowski, H.-J.; Kuske, S.; Rozenberg, G.: Graph transformation units – an overview. In: Degano, P.; Nicola, R. D.; Meseguer, J. (Eds.): *Concurrency, Graphs and Models, volume 5065 of Lecture Notes in Computer Science*. Springer, 2008, pp 57–75.
- [8] Rozenberg, G. (Ed.): *Handbook of Graph Grammars and Computing by Graph Transformation, volume 1: Foundations*. World Scientific, Singapore 1997.
- [9] Ehrig, H.; Kreowski, H.-J.; Montanari, U.; Rozenberg, G. (Eds.): *Handbook of Graph Grammars and Computing by Graph Transformation, volume 3: Concurrency, Parallelism, and Distribution*. World Scientific, 1999.
- [10] Kuske, S.; Luderer, M.: Autonomous units for solving the capacitated vehicle routing problem based on ant colony optimization. *Electronic Communications of the EASST*, 2010, pp 23, 26.
- [11] Kuske, S.; Luderer, M.; Tönnies, H.: Autonomous units for solving the traveling salesperson problem based on ant colony optimization. In: Kreowski, H.-J.; Scholz-Reiter, B.; Thoben, K.-D. (eds) *Dynamics in Logistics*, Springer, Berlin Heidelberg, 2011, pp. 289–298.
- [12] GrGen.NET: A fast, expressive, and general purpose graph rewrite tool. In: Schürr A., Nagl M., Zündorf A. (eds) *Proc. 3rd Int. Symposium on Applications of Graph Transformation with Industrial Relevance (AGTIVE'07)*, Lecture Notes in Computer Science, vol 5088, pp.568–569.



### Larbi Abdenebaoui, Dipl. Inf.

Email: larbi@informatik.uni-bremen.de  
Country: Morocco  
Start: 01.10.2012  
Supervisor: Prof. Dr. Hans-Jörg Kreowski  
Faculty: Mathematics / Computer Science  
Research Group: Theoretical Computer Science  
Funded by: Rosa-Luxemburg Stiftung



# Fashion Forecasting in Social Media: A Qualitative Comparison of Relevant Channels

Samaneh Beheshti-Kashi

**Fashion markets often face challenges in accurate demand forecasting. Since most production sites are placed in Asian countries, while European countries are the target customer, the time-to-market of fashion products is longer compared to the actual sales periods. Production decisions have to be placed before exact demands are available. In order to obtain information on potential future trends in advance, one possible approach is to include social media into fashion forecasting processes. The objective of this paper is to explore three different social media channels, namely weblogs, microblogging services and social network sites regarding fashion related information. For this purpose we selected 28 German fashion weblogs and conducted a qualitative analysis.**

**Introduction >>>** Fashion markets are often characterized by high impulse buying decisions of the costumers. Therefore, the availability of products at the point-of-sale is essential for companies. On the other hand, also overstocked inventories lead to losses [1]. In order to avoid these both cases, companies require accurate knowledge about future demands. However, precise demands are usually not available for companies. Demands are often influenced by several factors such as the economic situation of a country, public holidays, changing weather conditions, competition or even celebrities. Based on [2], Figure 1 gives an overview on the different influencing variables on forecast results. Fashion companies have to place their production plans several months before the actual delivery since most production plants are placed in Asian countries, such as China or Bangladesh, whereas the target countries are mainly European countries [3]. Therefore, the time-to-market for fashion products is longer compared to their actual sales period. For this reason, the re-production of good selling articles is hardly possible and often related to additional costs for companies: they can produce the articles in the Asian plants and fly them to Europe, or they place these orders in plants in Turkey or Northern African countries in order to be time efficient. In addition to volatile demands, [4] high product varieties in terms of colors and sizes are considered as further challenging aspects of fashion forecasting. Moreover, 95% of articles of a collection are replaced in the future seasons. As a result, companies are faced with limited data of past collection. Due to the described characteristics, standard foreca-

sting methods such as exponential smoothing or Holt-Winters models face some challenges. In particular, the lack of historical data creates challenges for these models. More advanced models such as the application of artificial neural networks, fuzzy logic, extreme learning machine or hybrid models are discussed in some literature [5][6][7]. Their models achieve more accurate results than standard methods. Though, due to their complexity, it is difficult to implement them into the processes of the companies. This paper presents a different perspective on the topic. In contrast to the described models, this work focusses on the approaches to adjust baseline forecasts. Beheshti-Kashi et al. (2015) give a detailed review on current fashion forecasting approaches and add the perspective of considering user generated content into fashion forecasting processes [8]. This research follows that approach and suggests that it is necessary to examine the different channels, in order to select the relevant and adequate ones for the extraction of future fashion trends. <<<

**Figure 1:** Influencing Factors on Forecast Results

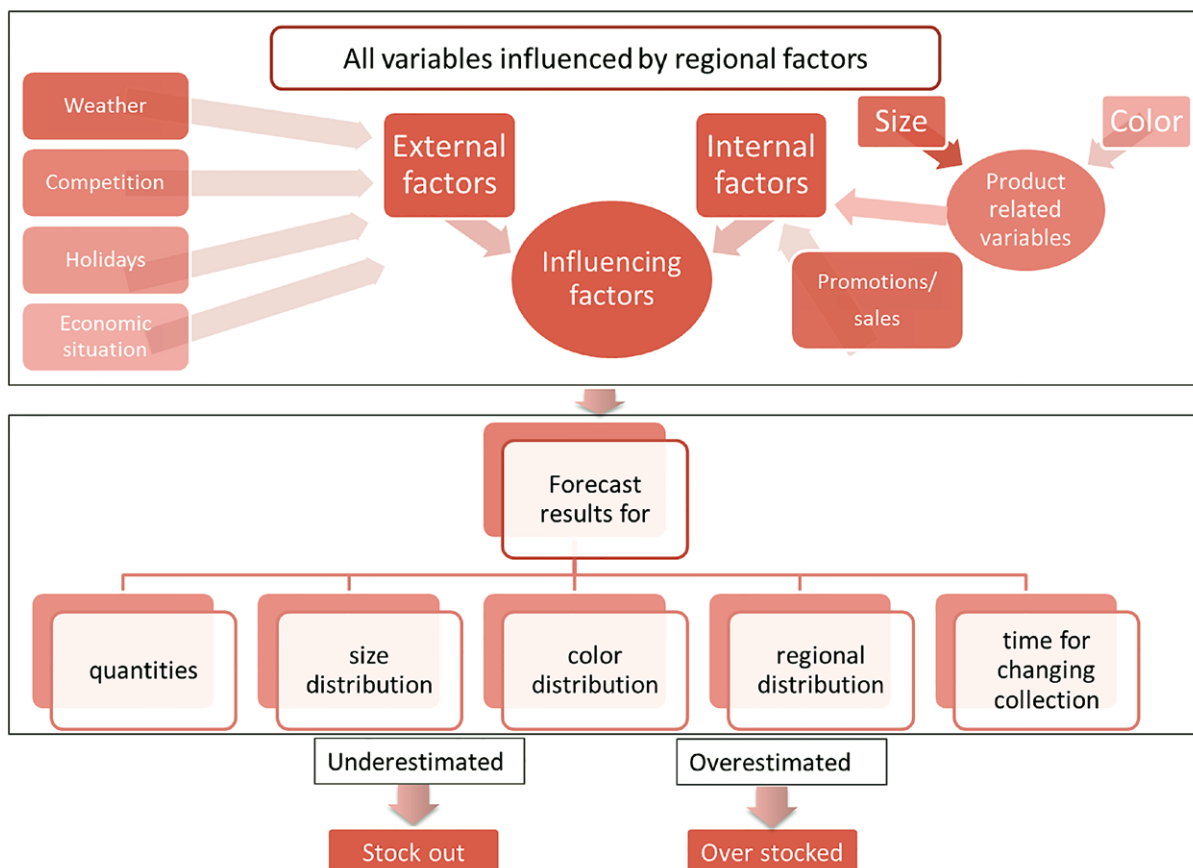

## Social media, social software and social network sites

With the rise of Web 2.0 new technologies have emerged. These technologies, often referred to as social media, have changed the role of the consumer towards an active and producing user. Every ordinary user has obtained the possibility to publish his or her opinion and experiences on a certain product or service. Since the fashion industry is highly consumer-oriented, the consumers' behavior and attitude towards products impact the success of companies. Therefore, the published information is valuable for companies.

Within the social media discussion different terms are often mixed up and used equally, such as social media, social software and social network sites. In order to differentiate them and use the terms in a correct way, we give some definitions.

Kaplan and Haenlein (2010, p. 61) define Social Media as a *group of Internet-based applications that build on the ideological and technological foundations of Web 2.0, and that allow the creation and exchange of User-Generated Content* [9].

In contrast to this definition, Schmidt (2009) uses the term social software and distinguishes them into four main categories: *Personal Publishing, Platforms, Information management tools and wiki* [10]. For the purpose of this paper we will focus on two categories: from the first category, microblogging services and weblogs will be considered; social network sites are selected from the second category; Information management tools and wikis are neglected in this research.

Merriam Webster defines weblogs as a *website that contains an online personal journal with reflections, comments, and often hyperlinks provided by the writer* [11]. The so called blogosphere consists of different blogs focusing on different topics such as daily news, health blogs, political blogs, war blogs or fashion blogs. In this research we focus on fashion blogs. The first fashion blog was created in 2003 in the USA. Since then the fashion blogger obtained increased attention from consumers. Moreover, fashion companies and designers have noticed the relevance of these blogger and supported them for instance by inviting them to their fashion shows with the aim that they publish information on their new collections.

One of the most successful microblogging services is Twitter with currently 288 million monthly active users. Every registered user can send messages over the service. The messages are limited to 140 characters. Currently, 500 million messages are published on a daily basis (Twitter, 2015).

The leading social network site is Facebook which was founded in 2004 in the USA. Boyd and Ellison (2007) define social network sites as follows:

*„We define social network sites as web-based services that allow individuals to (1) construct a public or semi-public profile within a bounded system, (2) articulate a list of other users with whom they share a connection and (3) view and traverse their list of connections and those made by others within the system. The nature and nomenclature of these connections may vary from site to site.“* [12]

## Qualitative Analysis of German Fashion Blogs

### The structure of a typical fashion blog

For this paper we conducted a qualitative analysis of 28 German fashion blogs. In our blog pool, all of the weblogs are written by young women, all living in Germany and writing in German. These so called fashion bloggers publish fashion related topics and discuss fashion trends on their personal weblogs. Often they present an outfit for a certain occasion such as a fashion event, a birthday party or just a day at work. A typical blog article contains several pictures showing the blogger with her current outfit from several perspectives. The pictures are embedded into the text, in which the products are described. Additionally, information on the occasion for which the outfit was created for, are given. In order to give their readers the chance to purchase the presented articles, the products are often linked to the corresponding web shops. In case the product is not available in a shop or is handmade, similar items from other brands or designer are linked. Usually, readers can comment the blog articles and give their feedback to the presented outfit. The blogger's intention is obtaining attention and reaching huge masses. Therefore, two strategies are often followed: Each article can be shared or the weblog as a whole can be followed. In order to share an article, the reader requires a user account for the given channels. For the purpose of following the weblog, the blogger uses accounts on other social media channels such as Twitter, Facebook, Instagram, Pinterest, Bloglovin or YouTube and link them on the weblog. In addition, the weblog can be followed by subscribing the RSS feed. Therefore, content is published in diverse channels besides their personal weblog. The number of offered to-follow possibilities depends on the engagement of the blogger. Since this research solely considers text, other channels, such as the video or photo platforms, are neglected in this exploration. For the analysis, the 28 weblogs served as data base.

### Cross channel comparison

For comparative purposes, we selected the two channels Twitter and Facebook. As a first step, we took the names of the weblogs, and searched within Twitter and Facebook for the corresponding accounts, in order to find out if the blogger use additional channels for publishing. From the 28 weblogs, 3 blogger do not use Twitter for publishing content, 1 blogger uses Twitter by the usage of a hashtag, not as a user. So called Hashtags can be created by users to refer to certain topics or events. For instance, the #fashion is added to most Tweets including some fashion topics. From the 28 blogger, 27 bloggers have in addition a Facebook page for publishing content about fashion. However, this one user has only a Twitter account. Therefore, all 28 blogger either use Twitter or Facebook as an additional channel, besides their own fashion weblogs. As a user name in both channels, the name of the weblog is being used.

This research is driven by the question: Do fashion blogger publish the same information in all the three channels? In this case, it is redundant to monitor and analysis all of the channels. However, this question only arises when we focus on the blogger as the distributor of fashion related content.

After examining the appearances of the blogger in the different channels, we consider the actual messages. The date of publication, the content and some formal aspects, such as the length of the message served as primary criteria for the comparison. As a first step, the latest published articles in the weblog were compa-

red to the latest Tweet and latest message on Facebook. The analysis shows that it is not sufficient to limit the examination to the latest published message on each platform. The posting frequency differs in the different channels. For instance, the latest published blog article does not correspond to the latest Tweet. The number of published Tweets is higher than the number of blog articles in the same period of time. One possible reason is the limitation of 140 characters. The effort of publishing a whole article about a product or outfit is higher than a short message. For this reason, it was not possible to compare the latest published messages. Again, the weblog article served as the basis to search for corresponding Tweets or Facebook messages. For this purpose the title of the weblog article served as search query. The search shows that for each weblog article a corresponding Tweet or Facebook message was found. Though, in most cases a link to the weblog article with a picture and short message was published both in Twitter and Facebook at the same day but often not at the same time. The messages on the three platforms also differ in formal aspects such as the length of the article and the number of pictures. Though, Facebook limits a message to 60.000 characters, often weblog articles are not fully copied and published. One possible motivation for this posting behavior is the bloggers' intention to attract their readers to their personal weblogs. However, even on weblogs the length of articles differ. From our data pool we could not identify any golden rule that the blogger follow regarding the length of an article.

A further differentiating aspect is the use of language. In weblog articles we find full sentences, which follow correct grammar rules. Due to the sign limitations, Tweets often contain abbreviations or emoticons. In addition, Tweets or Facebook messages are similar to chat conversations, since it is possible to react directly to a Tweet by retweeting, for instance. This effect is leveraged by the increased mobile usage of Twitter and Facebook. It has increased within the last years, and experts predict a further increase for the future [13]. For instance, in Germany 15, 1 % (2013) of the user have mobile access to Facebook and the prediction for 2018 is that 22, 3 % will use Facebook mobile. This could also be an indicator for the higher posting frequency rate in Twitter and Facebook.

## Conclusion

In order to apply social media platforms for fashion forecasting, it is necessary to select the right sources. Therefore, an examination of potential sources is a relevant task before the actual processing of the data. For this purpose we conducted a qualitative analysis of 28 weblogs and compared the content to the blogger's account on Twitter and Facebook. The question, which was followed for this analysis was, is it necessary to monitor all three channels, or do we have the same or similar content in all the three channels. This qualitative analysis shows that in the case of the 28 blogger, the weblog is the first and main channel to publish their content. Though, most of them additionally use either Twitter, Facebook or both channels for distributing information, we suggest to focus on the weblogs.

## References

- [1] Nenni, E. M.; Giustiniano, L.; Pirolo, L.: Demand Forecasting in the Fashion Industry: A Review. In: *International Journal of Engineering Business Management* 5 (2013), p 1.
- [2] Thomassey S.: Sales forecasts in clothing industry: The key success factor of the supply chain management. In: *International Journal of Production Economics* 128 (2010) 2, pp 470–483.
- [3] Mostard, J.; Teunter, R.; de Koster, R.: Forecasting demand for single-period products: A case study in the apparel industry. In: *European Journal of Operational Research* 211 (2011) 1, pp 139–147.
- [4] Christopher, M.; Lawson, R.; Peck, H.: Creating agile supply chains in the fashion industry. In: *International Journal of Retail & Distribution Management* 32 (2004) 8, pp 367–376.
- [5] Thomassey, S.: Sales forecasts in clothing industry: The key success factor of the supply chain management. In: *International Journal of Production Economics* 128 (2010) 2, pp 470–483.
- [6] Xia, M.; Zhang, Y.; Weng, L.; Ye, X.: Fashion retailing forecasting based on extreme learning machine with adaptive metrics of inputs. In: *Knowledge-Based Systems* 36 (2012), pp 253–259.
- [7] Wong, W. K.; Guo, Z. X.: A hybrid intelligent model for medium-term sales forecasting in fashion retail supply chains using extreme learning machine and harmony search algorithm. In: *International Journal of Production Economics* 128 (2010) 2, pp. 614–624.
- [8] Beheshti-Kashi, S.; Karimi, H. R.; Thoben, K.-D.; Lütjen, M.; Teucke, M.: A survey on retail sales forecasting and prediction in fashion markets. In: *Systems Science & Control Engineering: An Open Access Journal* 3 (2015) 1, pp 154–161.
- [9] Kaplan, A. M.; Haenlein, M.: Users of the world, unite! The challenges and opportunities of Social Media. In: *Business Horizons* 53 (2010) 1, pp 59–68.
- [10] Schmidt, J.: *Das neue Netz. Merkmale, Praktiken und Folgen des Web 2.0.* UVK Verlagsgesellschaft, 2009.
- [11] Merriam Webster: Full Definition of BLOG. URL: <http://www.merriam-webster.com/dictionary/blog>, Date of access 01.09.2015.
- [12] Boyd, D. M.; Ellison, N. B.: Social Network Sites: Definition, History, and Scholarship. In: *Journal of Computer-Mediated Communication* 13 (2007) 1, pp 210–230.
- [13] eMarketer: Anzahl der mobilen Nutzer von Facebook in Deutschland in den Jahren 2013 und 2014 sowie Prognose bis 2018 (in Millionen). URL: <http://de.statista.com/statistik/daten/studie/380630/umfrage/anzahl-mobiler-nutzer-von-facebook-in-deutschland-als-prognose/>, Date of access 01.09.2015.



### Samaneh Beheshti-Kashi, M.A.

Email: bek@biba.uni-bremen.de  
Country: Germany  
Start: 01.08.2013  
Supervisor: Prof. Dr.-Ing. Klaus-Dieter Thoben  
Faculty: Production Engineering  
Research Group: Collaborative Business in Enterprise Networks  
Funded by: University of Bremen

# A Flexible Integrated forward/reverse Logistics Model Using Metaheuristic Algorithms

Elham Behmanesh

Due to business and environmental issues, industrial players are under pressure to take back the product after its use. Moreover, the significance of transportation cost and customer satisfaction spurs an interest to develop a flexible network design model. This paper proposes an integrated logistics network model with three kinds of delivering paths. Minimizing the total costs reveals a mixed integer linear program. As a solution methodology for the proposed NP hard problem, a metaheuristic algorithm is applied. To validate our approach, we plan to compare our results with solutions from optimization software for small size problems, and to illustrate its scalability and power in comparison with other metaheuristic algorithms.

**Introduction >>>** The forward supply chain involves the movement of products from the upstream supplier to the downstream customer. The reverse supply chain focuses on the backward flow of materials from customer to supplier for possible recycling and reuse. In order to avoid sub-optimality of a solution derived by the separated design of the forward and reverse network, the forward and reverse supply chain should be integrated [1]. Previous researchers in this area of forward, reverse and integrated logistics network design are often limited themselves to analyze the flow between two consecutive stages. Nevertheless, considering flows between facilities, which are not sequential, this will increase the logistics network efficiency and flexibility. Within this work, we describe a flexible model for single period, single product, multi-stage integrated forward/reverse logistics network design, including supplier, production, distribution, collection/inspection, that could support both recovery and disposal activities with limited capacity.

<<<

## Problem definition

From the published literature, it is understood that the integrated forward/ reverse logistics problems are different from traditional logistics models [1]. Due to their size, these problems are more complex and require more efforts to analyze. The integrated forward/revers logistic network (IFRLN) discussed in this work is a seven-stage logistic network. As illustrated in Fig. 1, in the forward flow, new products are shipped from plant to customer zones through distribution and retailer centers in a pull manner to meet the demand of each customer. Customer locations are assumed to

be predetermined and fixed. In the reverse flow, returned products are collected by collection/inspection centers and, after inspection, the recoverable products are shipped to recovery facilities, and scrapped products are shipped to disposal centers in a push manner. Also three kinds of shipment are used in the proposed network to enhance the logistic network efficiency and flexibility [2].

- Normal Delivery: with this method, products are delivered from one echelon to another.
- Direct Shipment: with this method, products are transported from plants to customers directly.
- Direct Delivery: with this approach, products are transported from DCs to customers or via plants to retailers directly.

The objective function is to minimize the total cost including transportation and processing costs. The main issue addressed by this study is to determine both the optimal number and capacity of plant, distribution, retailer, collection/inspection and disposal centers, as well as the product flow between the facilities.

It goes without saying that applying a flexible logistics model improves the flexibility and efficiency of supply chain network. Moreover, using the new delivery routes makes the problem more complex. Hence, obtaining an accurate and efficient algorithm to tackle these NP hard problems is necessary.

**Figure 1:** Framework of the flexible integrated forward/reverse logistics model

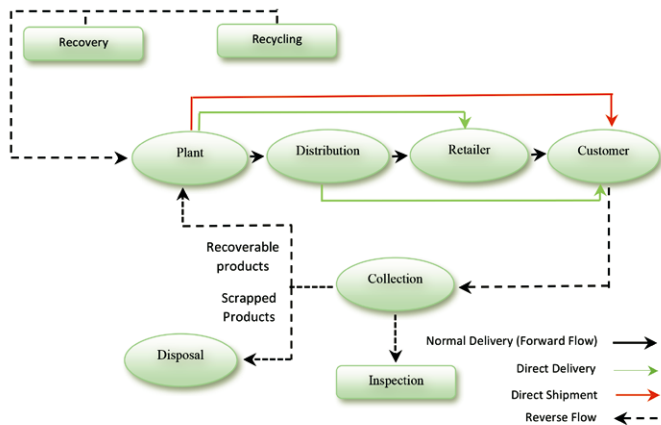

## Solution approach

There are three main options to tackle NP hard problems: probabilistic algorithms, approximation algorithms and meta-heuristic algorithms. Due to reducing the space search and increasing the quality of the solution, we consider meta-heuristic algorithms as a solution approach. Among those, genetic algorithms (GAs) may be an appropriate approach for closed loop supply chain model [3]. The basic feature of GAs is a multi-directional and global search by maintaining a population of solutions from generation to generation. However, pure GAs often lack the capability of sufficient search intensification [4]. Moscato and Norman [5] first defined a memetic algorithm (MA) to integrate local search in GAs to improve the intensification of the search. MAs are population-based heuristic search approaches for optimization problems, which have shown practical success in a variety of problem domains, and in particular for the approximate solution of NP-hard optimization problems. Hence, both GA and MA algorithms are appropriate solution methods, particularly in the large scale case. Comparing respective solutions can be considered a good method to show the efficiency of these algorithms in a closed loop supply chain. Moreover, small test problems can be solved via LINGO, GAMS or CPLEX optimization software to test the accuracy of the proposed MA and GA.

## Conclusion

This work addresses the issue of flexible integrated, multistage forward/reverse logistics network design which aims to minimize the total cost of opening facilities and transportation in the proposed network. IFRLN is not a case-based network and because of its generic nature, it can support a variety of industries such as electronic and digital equipment industries and vehicle industries. Many research directions still require intensive research in the area of closed-loop logistics network design problems. Moreover, since network design problems belong to the class of NP-hard problems, developing efficient solution methods is still a critical need in this area.

## References

- [1] Pishvae, M.S.; Jolai, F.; Razmi, J.: A stochastic optimization model for integrated forward/reverse logistics network design. In: *Journal of Manufacturing Systems* 28 (2009) 4, pp 107-114.
- [2] Gen, M.; Cheng, R.; Lin, L.: *Network, Models and Optimization: Multi objective Genetic Algorithm Approach (Decision Engineering)*. Springer, London 2008.
- [3] Kannan, G.; Sasikumar, P.; Devika, K.: A genetic algorithm approach for solving a closed loop supply chain model: A case of battery recycling. In: *Applied Mathematical Modelling* 34 (2010) 3, pp 655-670.
- [4] Pishvae, M.S.; Farshani, R.Z.; Dullaert, W.: A memetic algorithm for bi-objective integrated forward/reverse logistics network design. In: *Computers and Operations Research* 37 (2010) 6, pp 1100-1112.
- [5] Moscato, P.; Norman, M.G.: A memetic approach for the traveling salesman problem implementation of a computational ecology for combinatorial optimization on message-passing system. In: Valero, M.; Onate, E.; Jane, M.; Larriba, J.L.; Suarez, B. (Eds.): *Parallel computing and transporter applications*. IOS Press, Amsterdam 1992, pp 86-177.



**Elham Behmanesh, M.Sc.**

Email: beh@biba.uni-bremen.de  
 Country: Iran  
 Start: 01.11.2014  
 Supervisor: Prof. Dr. Jürgen Pannek  
 Faculty: Production Engineering  
 Research Group: Dynamics in Logistics  
 Funded by: Graduate School Scholarship Programme (GSSP), DAAD

# Trust Dynamics in Early Phases of Supply Chain Collaboration

Morice Daudi

Trust is a complex construct and particularly dynamic in nature. It changes its form or states over time. Trust is born, shaped, generalized and subsequently specified according to underlying applications. In order to improve trust supported collaborative alliances in supply chain; partners require an understanding on how trust progresses since its birth. Such mechanisms facilitate partners with a “know how” in developing and advancing mutual trust. This paper analyzes dynamics of trust in early phases of supply chain collaboration. The early phases begin from when trust is born up to the creation phase. The paper presents also distinct form or states of trust along transition lines. In order to achieve the intended objective, the paper applies a formal deductive approach. Hence, some logical rules and argumentations from organizational development and change are applied. Results show that at birth and shaping layers, trust is slightly processed and extremely generic. In preliminary storage layer trust is slightly specific and existing in multiples of: dimensions, criteria, types, roles and level. Moreover, life-cycle model drives trust change between trust birth and preliminary storage; while evolutionary model drives trust change in the preparatory phase.

**Introduction >>>** Today, Supply Chain Management (SCM) is increasingly adapting collaboration as one of the strategies to combat emerging production challenges. Through a collaborative strategy, manufacturing and logistics industries are expectedly gaining competitive advantages. They reduce production costs, observe environmental regulations and respond better to the complexity of market requirements [1, 2, 3]. Despite of all such benefits, the adoption of supply chain collaboration is relatively challenging. One of the limiting factors identified in research and practice is trust. Trust is a potential barrier in adoption of supply chain collaboration [4, 5, 6, 7] and makes collaboration a difficult proposition to many companies [8]. Moreover, apart from being the barrier, trust is a complex construct.

Trust is considered a dynamic construct [9,10] as it changes over time. The change involves a particular form or state of trust adjusting into other distinguishable one. Moreover, trust complexity arises through other perspectives as well. Trust involves interactions which are tightly coupled, reciprocal [11], history dependent [12], adaptive, self-organizing, and non-linear. Initially, tightly coupled

interactions occur when trust involves relationships whose interactions intensities are relatively higher. As a reciprocal construct, trust exhibits partial temporal forms, “a cause and an effect of change” [11]. Trust is history dependent, as it can be assessed on the accumulation of past records, within a specific period of time. Correspondingly, trust is adaptive as partners are able to regulate own trust level(s), as a result of the environmental influences.

In order to analyze and clarify discussions on trust dynamics, a definition of trust in [13] is adopted and slightly modified. Thus, the paper refers to trust as a “*specific level of confidence developed by one party (trustor) into the other party (trustee), based on the expectation that the trustee will perform a particular action important to the trustor, irrespective of the ability to monitor or control the trustee*”.

The rest of the paper is organized in 5 sections. Section 2 defines research problem, and section 3 presents theories of development and change. A conceptual model of trust dynamics is presented in section 4, followed by an illustrative example in section 5. Finally, conclusion and outlook are presented in section 6. <<<

## Problem definition

Over time, trust evolves in a particular way depending on the specific history of actions and interactions and other events taking place [11]. Trust is acquired by an actor depends on initial trust and trust dynamics [14]. In [15], they examine whether and in what form is trust influenced by experiences. They show that, previous experiences of the agent impacts subsequent trust. However, there appears a limited understanding on trust dynamics examined in other views. Therefore, the paper analyzes dynamics of trust in supply chain collaboration, from when trust is born up to the creation phase (figure 1).

**Figure 1:** Life-cycle phases of supply chain collaboration (Adopted and modified from [16])



The purpose is to broaden an understanding on how trust changes its form or states over time along different layers (figure 2). The paper investigates trust dynamics in perspectives of: role of trust, dimensions, criteria and level.

## Theories of development and change

The section introduces evolution and life-cycle theories, appropriate to govern trust change processes. Initially, the evolutionary model of development consists of a repetitive sequence of variation, selection, and retention events among entities in a designated population [17]. It engages in multiple entities undergoing a prescribed model of change on a base of competitive survival. On the other hand, life-cycle theory describes a development involving a single entity undergoing a change process in a prescribed model. In the life-cycle theory, the developing entity has within it, an underlying form, logic, program, or code that regulates the change process [17]. The progression of change events is a unitary sequence, and cumulative such that early acquired characteristics are retained in later stages" [17]. The two theories of development and change are relevant to describe dynamics of trust in supply chain collaboration.

## Conceptual model of trust dynamics

In this section, dynamics of trust are analyzed in the perspectives of: multi-criteria, multi-dimensions and multi-level. Additionally, the paper presents also such dynamics in a view of types and roles of trust plays. All discussions are reflected in figure 2.

### Trust dynamics in the trust origin and shaping layers

Trust originates from competency of objects, and social structure comprising of both, formal and informal [18] arrangements. Trust produced through object's competency and formal institutions is shaped by the role of third parties [18]. Third parties shape trust by applying formal frameworks, comprising of specific rules and regulations established for a purpose. On the other hand, trust produced through informal institutions is shaped by friends, relatives and alumni" [18], through informal rules and regulations. Such informal frameworks may exist by chance or be established for a purpose.

In the process of trust production, the entity (firm, department or personal representative) is solely responsible in regulating its degree of trust. It regulates trust by exhibiting its collaborative behaviors or actions to the shapers. As a result, at different points in time, the entity signals distinct degree of trust into the shaping layer. However, while in the source layer, trust remains extremely generic and meaningless to apply as it is yet unshaped. On transition to the shaping layer, trust undergoes life-cycle change under shaping of the specific rules and regulations.

### Trust dynamics in the preliminary storage layer

In the preliminary storage layer, trust exists in multiple dimensions of ability (competence), integrity and benevolence. As well, trust exists in diverse criteria and multiple levels, subject to the way trustor specifies. Correspondingly, trust is categorized as rational or subjective, conforming to formal and informal originality and shaping mechanisms.

At different points in time, the preliminary storage contains distinct trust data. Such trust data belongs to a single entity, and may even accumulate within a specific period. Even though, trustor can also postulate entity's trust in a particular point in time. To exemplify this, consider an organizational entity in supply chain collaborative alliance. It is possible to point out, how trustworthy the organizational entity had been for the past six months under specific criteria and dimensions. Relatedly, in a specific month, trustworthy of the same organizational entity can be postulated.

### Trust dynamics in the preparatory phase for alliance formation

In a transition from the preliminary storage to a preparatory phase, trust undergoes filtration. In the filtration process, trust is made more specific to apply in terms of criteria, dimensions and levels. It can be remembered that "trust develops from relationship history and expectation on forthcoming relationship" [18]. However, to develop trust from relationship history, a purposeful preparatory environment must exist in prior. The preparatory environment provides prospective partners a chance to interact, familiarize and exchange own trustworthiness in prior.

Therefore, every prospective partner in the preparatory phase has an initial *base trust*. Such initial base trust is updated as a result of trust signals received from the preliminary storage layer. Hence, depending on the received trust signals, the current base trust is the accumulation of trust within a specific period of time. Above all, before updating the base trust, the trustor specifies applicable trust dimensions, criteria and level. Hence, within a specific time slot, distinct form and states of trust dimensions, criteria and level exist.

In the preparatory phase, prospective partners' trusts undergo an evolutionary change. Expressively, partners compete to win selection in order establish a collaborative alliance for a realized business opportunity. Particularly in creation phase (figure 1), trust exists predominantly in a form of partner's ability to execute supply chain collaborative responsibilities. In contrast, integrity-based trust is less applied because it relates to partner's compliance with collaborative agreements in the operational phase.



**Figure 2:** A conceptual model of trust dynamics

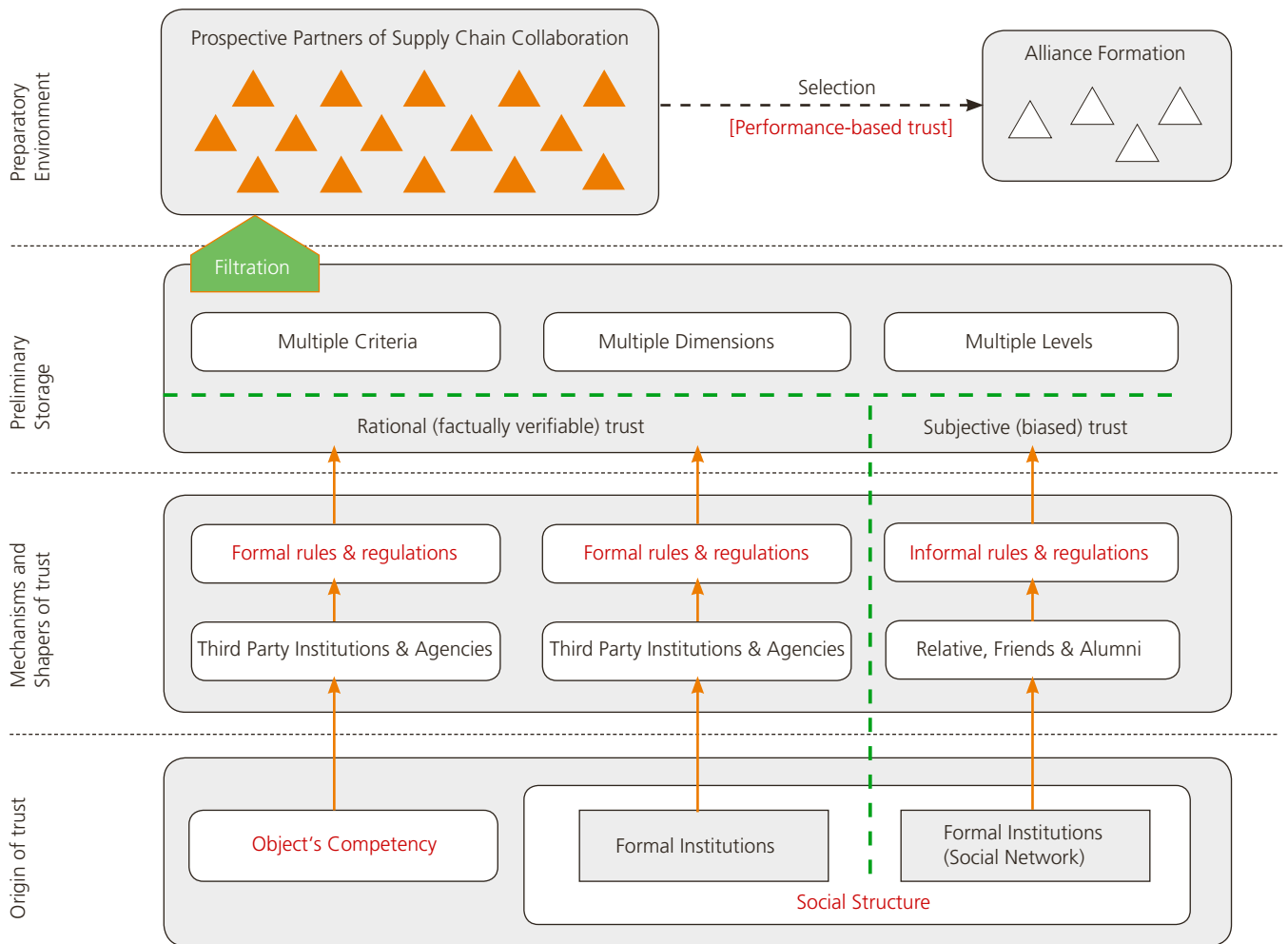

### Illustrative example

The section illustrates an example of trust dynamics in the application of shared transportation vehicles. In the beginning, administrator of the prospective alliance specifies required competencies for organizational entities aspiring to be selected. Required competencies of the partner, as trust criteria can include: geographical coverage, number of vehicles owned and delivery efficiency. Subject to availability of trust data, the administrator decides objectively on the weight distribution between rational and subjective trust. Afterwards, the administrator develops relevant rules and regulations to shape trust, and correspondingly identifies specific shapers. Rules and regulations may include presenting certified recommendations, audited reports and asset ownership. In this context, shapers consist of certifying authorities, auditor firms and customer comments. Thus, for every contestant partner, desired trust history and/or trust in a specific time is measured and assessed accordingly.

### Conclusion and outlook

The paper has analyzed how trust changes overtime. The trust change is analyzed along diverse layers: from when trust is born up to the creation phase in the supply chain collaboration. It is shown that trust adjusts into diverse form and state over time. Since its birth and shaping, trust is extremely general to apply, until it becomes specific in subsequent layers. In the preliminary storage, trust exists in multiple dimensions, criteria and level. In the creation phase, trust takes the form of ability – how a prospective partner is capable of executing its responsibilities. The paper has also presented how entity's trust accumulates over a period of time. In spite of the contribution presented, future research direction may include investigating trust dynamics in the operation phase of supply chain collaboration.

## References

- [1] EFFRA: *Factories of the Future PPP - FoF 2020 Roadmap: Consultation document*. URL: [http://www.effra.eu/attachments/article/335/FoF-Roadmap2020\\_ConsultationDocument\\_120706\\_1.pdf](http://www.effra.eu/attachments/article/335/FoF-Roadmap2020_ConsultationDocument_120706_1.pdf), Date of access 22.07.2014.
- [2] Koh, S.C.L. et al.: *Overview of Enterprise Networks and Logistics for Agile Manufacturing*. In: Koh, S.C.L.; Wang, L. (Eds.): *Enterprise Networks and Logistics for Agile Manufacturing*. Springer, London 2010, pp 1-10.
- [3] Lyons, A.; Coronado Mondragon, A.E.; Piller, F.; Poler, R.: *Network Collaboration: Vertical and Horizontal Partnerships*. In: *Customer-Driven Supply Chains*. Springer, London 2012, pp 95-111.
- [4] Pomponi, F.; Fratocchi, L.; Tafuri, S. R.: *Trust development and horizontal collaboration in logistics: A theory based evolutionary framework*. In: *Supply Chain Management: An International Journal* 20 (2015) 1, pp 83-97.
- [5] Hu, J.; Bian, W.; Han, S.; Ju, S.: *An Empirical Research of the Influence Factors of the Action from MF Network Collaboration to Logistics Organization Performance*. In: *AISS* 3 (2011) 6, pp 259-265.
- [6] Taneja, M.; Kalita, D.: *Partnering with Competitors to Reduce Logistics Costs, The Smart Cube*. URL: <http://www.thesmartcube.com/insights/blog/blog-details/insights/2014/11/11/partnering-with-competitors-to-reduce-logistics-costs>, Date of access 10.12.2014.
- [7] Baalsrud Hauge, J.; Kalverkamp, M.; Forcolin, M.; Westerheim, H.; Franke, M.; Thoben, K.-D.: *Collaborative Serious Games for Awareness on Shared Resources in Supply Chain Management*. In: Grabot, B. et al. (Eds.): *Advances in Production Management Systems. Innovative and Knowledge-Based Production Management in a Global-Local World*. Springer, Berlin Heidelberg 2014, pp 491-499.
- [8] Graham, L.: *Transport Collaboration in Europe*. ProLogis Corporate, Technical Rep., 2011.
- [9] Daudi, M.; Msanjila, S.: *Modeling of Evolution and Sustainability of Rational Trust in Dynamic VOs*. In: Camarinha-Matos, L.; Scherer, R. (Eds.): *Collaborative Systems for Reindustrialization*. Springer, Berlin Heidelberg 2013, pp 548-555.
- [10] Nielsen, B. B.: *Trust in strategic alliances: Toward a co-evolutionary research model*. In: *Journal of Trust Research* 1 (2011) 2, pp 159-176.
- [11] Huang, Y.; Wilkinson, I. F.: *The dynamics and evolution of trust in business relationships*. In: *Industrial Marketing Management* 42 (2013) 3, pp 455-465.
- [12] Greenberg, P. S.; Greenberg, R. H.; Antonucci, Y. L.: *Creating and sustaining trust in virtual teams*. In: *Business Horizons* 50 (2007) 4, pp 325-333.
- [13] Mayer, R.C.; Davis, J.; Schoorman, F.D.: *An integrative model of organizational trust*. In: *The Academy of Management Review* 20 (1995) 3, pp 709-734.
- [14] Jonker, C. M.; Treur, J.: *Formal analysis of models for the dynamics of trust based on experiences*. In: Garijo, F. J.; Boman, M. (Eds.): *Multi-Agent System Engineering, Proceedings of the 9th European Workshop on Modelling Autonomous Agents in a Multi-Agent World*. Springer, Berlin Heidelberg 1999, pp 221-232.
- [15] Jonker, C. M.; Schalken, J.J.P.; Theeuwes, J.; Treur, J.: *Human Experiments in Trust Dynamics*. In: Jensen, C.; Poslad, S.; Dimitrakos T. (Eds.): *Trust Management*. Springer, Berlin Heidelberg 2004, pp 206-220.
- [16] Thoben, K.-D.; Jagdev, H. S.: *Typological issues in enterprise networks*. In: *Production Planning & Control: The Management of Operations* 12 (2001) 5, pp 421-436.
- [17] Van de Ven, A. H.; Poole, M. S.: *Explaining Development and Change in Organizations*. In: *The Academy of Management Review* 20 (1995) 3, pp 510-540.
- [18] Nguyen, N. P.; Liem, N. T.: *Inter-firm trust production: Theoretical perspectives*. In: *International Journal of Business and Management* 8 (2013) 7, pp 46-54.



### Morice Daudi, M.Sc.

Email: dau@biba.uni-bremen.de  
Country: Tanzania  
Start: 01.10.2014  
Supervisor: Prof. Dr.-Ing. Klaus-Dieter Thoben  
Faculty: Production Engineering  
Research Group: Collaborative Business in Enterprise Networks  
Funded by: German Academic Exchange Service (DAAD)

# Optimization Techniques for Reversible Circuit

Arighna Deb

The design of reversible circuits is motivated by new emerging technologies such as quantum computing and the area of low-power computation. Reversible circuits are digital circuits with the same number of input signals and output signals. Furthermore, these circuits realize bijections, i.e. each input assignment maps to a unique output assignment. Accordingly, the output of a reversible circuit contains sufficient information to reconstruct the input i.e. no output information is erased. Recently, synthesis of such circuits become well studied topic. The main objective of the synthesis approach is to produce reversible circuit with small quantum cost. The quantum cost measures the complexity of a reversible circuit by estimating the number of elementary quantum operations in the circuit. However, most of the synthesis approaches do not produce an optimal reversible circuit with respect to quantum cost. Therefore, post-synthesis optimization technique is applied to produce an optimal reversible circuit.

**Introduction >>>** A reversible circuit is a cascade of several reversible gates including the Toffoli gate [1], the Fredkin gate [2] and the Peres gate [3]. In the following, types of the Toffoli gates are defined since they appear more frequently in any reversible circuit structure.

A multiple control of Toffoli gate has a target line and a set of control lines. The target line is inverted if all the control lines are set to 1; otherwise the value of the target line remains unchanged. A Toffoli gate with no control always inverts the target line and is called as NOT gate. While a Toffoli gate with a single control line is called a Controlled-NOT (CNOT) gate, the same gate with two control lines is called as only Toffoli gate. The gate with more number of control lines is known as multiple control Toffoli gate. <<<

**Figure 1:** Toffoli gate with two control lines

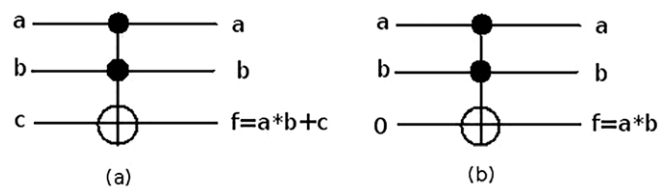

Fig. 1 (a) shows a Toffoli gate with two control lines (represented by solid dots) and a target line. This gate produces output  $f = a*b + c$  (where,  $*$  represents AND operation and  $+$  denotes EXOR operation) over the target line. If the target input  $c$  is set to 0, the gate realizes output  $f = a*b$ , i.e. an AND operation over the target line as depicted in Fig. 1 (b).

As mentioned earlier, the designs of reversible circuits are evaluated based on the quantum cost metric. The quantum cost of any reversible circuit is the addition of individual cost of reversible gates. In case of Toffoli gates, this quantum cost depends on the number of control lines of the gates. For example, a Toffoli gate with two control lines has quantum cost of 5, whereas, a Toffoli gate with three control lines has quantum cost of 14. Therefore, it has been observed that the higher the number of control lines, the higher is the quantum cost.

## Optimization approaches

The optimization of reversible circuits has been significantly considered in the recent past. A major focus has been put on the reduction of control line connections. This is caused by the fact that a gate with many control connections increases the quantum cost of a reversible circuit. Therefore, in order to reduce the overall quantum cost of a circuit, researchers have focused on the reduction of control connections in the circuit. Two approaches [4,5] exploiting reduction of control connections have been recently proposed.

In [4], common control connections, i.e. equal or similar control lines, are shared by adding extra signal lines to the circuit. This reduces the control connections, which in turn, reduces the quantum cost of the reversible circuit. But due to the additional signal lines, this method increases the number of circuit lines. The optimization approach reported in [5] merges all the gates with exactly same control connections but different target connections to a single gate. The experimental evaluations summarized in [4] and [5] show that the reductions in quantum cost can be achieved respectively up to 70% and 60%.

## Conclusion and outlook

The optimization approaches cited above produce optimal results for reversible circuits with respect to quantum cost. However, these existing solutions have some drawbacks and restrictions. The optimization method of [4] requires additional signal lines. In the context of quantum computation, these additional lines correspond to number of quantum bits (qubits), which are considered having very limited resources. The optimization approach in [5] is restricted to only exact control connections. It means that it fails to produce an optimized circuit when the control connections are unequal. Therefore, the future research must develop an optimization method which can overcome these limitations and also can produce better optimal circuits than the existing ones.

## References

- [1] Toffoli, T.: *Reversible computing*. In: de Bakker, W.; van Leeuwen, J. (Eds.): *Automata, Languages and Programming*, technical Memo MIT/LCS/TM-151, MIT Lab. for Comput. Science. Springer, Berlin Heidelberg 1980, pp 632-644.
- [2] Fredkin, E. F.; Toffoli, T.: *Conservative logic*. In: *International Journal of Theoretical Physics* 21 (1982) 3/4, pp 219-253.
- [3] Peres, A.: *Reversible logic and quantum computers*. In: *Physical Review A* 32 (1985) 6, pp 3266-3276.
- [4] Miller, D. M.; Wille, R.; Drechsler, R.: *Reducing reversible circuit cost by adding lines*. In: *40th IEEE International Symposium on Multiple-Valued Logic (ISMVL)*. Barcelona, Spain 2010.
- [5] Wille, R.; Soeken, M.; Otterstedt, C.; Drechsler, R.: *Improving the mapping of reversible circuits to quantum circuits using multiple target lines*. In: *ASP Design Automation Conference*. Yokohama, Japan 2013, pp 85-92.



### Arighna Deb, M.Tech.

Email: deb@informatik.uni-bremen.de  
Country: India  
Start: 29.07.2014  
Supervisor: Prof. Dr. Rolf Drechsler  
Faculty: Mathematics / Computer Science  
Research Group: Computer Architecture  
Funded by: Erasmus Mundus programme cLINK of the European Union

# A Green Logistics Oriented Framework for Integrated Production-Distribution under Uncertainty in the Batch Processes Industry

Nagham M. El-Berishy

**Integrating production and distribution functions in supply chain planning has proven to be very beneficial. However, there has been a lack of work adding the green logistics aspects to such integration, especially for the batch processes industry, and in cases of uncertainty. In this paper, we present, for the first time, a mathematical modelling framework for integrated production-distribution in the batch process industry. We incorporate the carbon emission aspects under uncertainty. These emissions are modeled as a function of randomly realized velocities at different distribution routes. The model will be applied in a real world case study.**

**Introduction >>>** Production and distribution operations are two key functions in today's supply chains. To achieve optimal operational performance in supply chains, it is critical to jointly integrate the planning of these two functions and try to minimize their costs simultaneously (Chen 2004). In addition, green logistics is increasingly gaining attention due to its economic, environmental, and social benefits. In today's global marketplace, companies must design their supply chain systems in a way which not only satisfies the need of their customers but also exceeds the environmental legislations of their governments (Zhu and Cote 2004, and Pinto Varela et al. 2011). Specifically, it is crucial to optimize total supply chain costs and environmental impacts simultaneously (Sazvar et al. 2014).

Different authors have presented models that deal with green supply chain designs (Wang et al. 2011). However, new models are required to address many other decisions (Dekker et al. 2012). Specifically, modelling production-distribution at the tactical-operational levels, while including green logistics issues, is something that has not been dealt with in the literature. In this paper, we present a mathematical modelling framework for the aforementioned case. For the green logistics part, we focus on the permissible carbon emissions generated during the distribution phase. However, according to the conclusions in NSF (Daskin and Benjaafar 2010), research needs to be done to address this problem in the context of supply chains and logistics systems, which is the area we tackle in the present study. The emissions we consider are related to the velocities of the vehicles used for distribution, which might be uncertain, due to the randomness associated with travel distances. Thus, we include such uncertainty as well in our framework.

Moreover, there is a lack of applications and case studies in this area that aim at validating theories and perspectives (Aronsson and Brodin 2006). In particular, applying green logistics in the

batch processes industry has not been presented in the literature before, to the best of the authors' knowledge. The batch process industry, in which typically a large number of products are made using similar production paths, are widely economically desirable (Stankovic and Bakic 2006). A batch process is frequently found in the fast moving consumer goods industry, food processing, chemical manufacturing, oil refining, and pharmaceutical industries (El-Berishy 2011). In addition to the previous characteristics, products which are distributed in batch forms could be considered environmentally friendly because they are transported using smaller packaging and joint distribution which mitigate carbon footprint (Ji et al. 2014). Our model is inspired by and applied to a real-world case study in this industry for a large multi-national company.

In this paper, we present an integrated two-stage stochastic programming model for production-distribution planning of products at the tactical-operational levels under uncertainty. The model includes the green aspect of the permissible carbon emissions, as a function of uncertain vehicle velocities. The rest of this paper is organized as follows: In Section 2, we review the literature related to our work. We then define our problem and develop our mathematical model in Section 3. Conclusions and directions for future work in Section 4. <<<

## Literature Review

In order to maximize the benefits and minimize the total cost for many enterprises, they tend to consider production and distribution decisions comprehensively rather than separately. The potential savings generated by the integration of production and distribution is addressed by Goetcschalckx et al. (2002) in their review paper. Researches had developed multiple models, like the study of

Glover et al. (1979), to achieve this goal. In Glover et al. (1979), a production, distribution, and inventory planning system for a batch process industry was presented and applied in a chemical company.

Despite the various researches in this area, Fahimnia et al. (2008) pointed out the necessity of developing an integrated optimization model that includes more elements of production and distribution costs. One of these cost elements that plays an important role nowadays is the environmental impact/costs (Srivastava 2007). Several recent papers focused on including different green supply chain aspects in the production-distribution modelling at different levels. Sheu et al. (2005) formulated a linear multi-objective programming model that optimizes the integrated operational logistics and the used-product reverse logistics in some green supply chain. Some other researchers studied green transportation issues at the operational level, such as Ubeda et al. (2011).

Al-e-hashem et al. (2013) formulated a model for aggregate production plans that considers uncertainty in customers' demands. Their model generates tactical relected decisions in a green supply chain. Some models deal with the facility location and supply chain planning at the strategic level. For instance, Jouzdani et al. (2013) presented a facility location model under demand uncertainty and traffic congestion. They applied their work on a case study of a milk and dairy products facility and measured both economic and environmental costs.

At the operational level, Zhang and Xu (2013) modelled a production planning optimization problem which included both production and carbon trading decisions. Last but not least, transportation and inventory decisions at tactical and operational levels, as well as the environmental impacts, were the main focus of the model presented in Sazvar et al. (2014). Their objective was to strike a balance between financial and environmental criteria under uncertain demand. None of these models integrated the green aspect of carbon emissions with the tactical-operational supply chain planning. We integrate these issues in our model below.

Recently, a lot of researchers incorporated uncertainty in their integrated models. Examples are the models of Cheung and Powell (1996), Bidhandi and Rosnah (2011), Georgiadis et al. (2011), and Long and Zhang (2014). The uncertainty they included is concerned with the different supply chain costs, customer demand, among others. However, we focus on a different kind of uncertainty, which is the uncertainty in travel distances and thus the permissible velocities of vehicles used in demand delivery. Then, we link that to the produced carbon emissions, and incorporate all this in our integrated green production-distribution model. Thus, on the contrary of other models in the literature, we exploit the uncertainty in the green aspects of the supply chain for the first time, rather than that of the production and distribution pieces.

## Problem definition and model development

In our problem, there are multiple products that can be produced in batches in a single plant. The planning problem is multi-period with a given short planning horizon. Production capacities are assumed to be known. Typically, the planning horizon is a month, with weekly or bi-weekly periods. The plant is the single depot out of which products (batches) are to be distributed to a number of known customer locations with a known deterministic demand.

Carrying inventory of any product from one period to the next is allowed at the single plant. Safety stocks and inventory capa-

cities are also assumed to be known and deterministic. Delivery vehicles are homogeneous in size and type with a known capacity. The number of used vehicles varies from one planning period to another according to the resulting distribution plan. No split delivery is allowed; for all locations to be visited, it is assumed that each location is visited only once in each time period with its full required batches delivered. We model the problem on a full graph  $G=(V,E)$ , where, the first node in the set  $V$  is the depot/plant, and the other nodes are the customer locations. We assume that production costs, transportation distances and costs throughout the whole network, as well as inventory holding costs, are known and deterministic.

We also include environmental aspects represented in the emitted carbon quantities. These greenhouse gas emissions are dependent on vehicle velocities. Those velocities are chosen between the minimum and maximum permissible velocity on each chosen route. However, due to uncertainty in travel times, these latter minimum and maximum velocities are random.

We assume that they follow a known joint probability distribution. Let  $\Omega$  denote the vector of the uncertain minimum and maximum velocities on each route (between any two nodes in our network) in each period, where  $\Omega = \text{Min}V, \text{Max}V, \text{Min}V$  corresponds to the minimum velocity,  $\text{Max}V$  corresponds to the maximum velocity, and  $\omega$  is a given realization of the uncertain parameters.

Given this uncertainty, our two-stage stochastic programming model dynamics works as follows: In the first stage, we take all production, inventory, and distribution decisions (i.e., choose the routes for demand delivery to customers). These decisions are taken so that we satisfy customer demand without exceeding any of the capacities and minimize the total costs of production, inventory, transportation, and the expected costs of the second stage problem. Depending on these decisions, we set the production schedule and rent the required vehicles for demand delivery.

Then, in the second stage, after uncertainty is revealed, we choose the velocity on each route as a value between the revealed minimum and maximum permissible values (that depends on the condition of the road and traffic/travel times on each time period for each route). This chosen velocity might result in emission values higher than the maximum permissible emission indicated by the government, or lower than the lowest permissible value (which is the lowest expected value for each vehicle type). Thus, in addition to the costs paid for emissions, for the former case, the company would have to pay an extra penalty to the government that is linearly proportional to the amount of overage emission for exceeding the maximum allowed carbon emissions.

While for the latter case, characterized by very low velocities, there would not be any extra emissions produced, but there would be delays in customer delivery. This happens in cases on rush hours, failure in the routes, etc. We penalize such delays and assume that they are linearly proportional to the amount of underage emission in the latter case. We minimize all these emission related costs and penalties in the objective function of our second stage problem. Note that our model has a relatively complete recourse (See Birge and Louveaux 2011); because for any feasible solution of the first stage problem, one can always construct a feasible solution for the second stage problem.

We now indicate our model notation:

### Sets

L	Set of Locations
P	Set of Products
T	Set of Time periods

**Parameters**

$B_l$	Environmental (emission trading) factor at location $l \in L$ (€/ emission unit)
$CAP$	Vehicle available capacity (batch)
$DC_{lk}$	Cost per unit distance for quantities en route between locations $l \in L$ and $k \in L: l \neq k$ (€/unit distance)
$D_{lk}$	Distance for the route between locations $l \in L$ and $k \in L: k \neq l$ (unit distance)
$EM_{lk}$	Emission constant for the route between locations $l \in L$ and $k \in L: l \neq k$ (emission unit/unit velocity)
$F_{lk}$	Additional cost per each above permissible emission unit en route between locations $l \in L$ and $k \in L: l \neq k$ (€/overage emission unit)
$G_{lk}$	Additional cost per each under permissible emission unit en route between locations $l \in L$ and $k \in L: l \neq k$ (€/underage emission unit)
$H$	Beginning inventory on-hand (batch)
$HC_{lp}$	Holding cost per unit per period of product $p \in P$ kept in inventory at location $l \in L$ (€/batch/period)
$IC_{tp}$	Available inventory capacity for product $p \in P$ in period $t \in T$ (batch)
$IRC$	Total available inventory resource capacity at the plant (total number of resources)
$IR_p$	Inventory resource utilization for producing one unit of production $p \in P$ (number of resources used/unit of product $p$ )
$MaxE$	Maximum permissible emission (emission unit)
$MinE$	Minimum permissible emission (emission unit)
$MaxV_{tlk}(\omega)$	Maximum velocity en route between locations $l \in L$ and $k \in L: l \neq k$ in time period $t \in T$ , for scenario $\omega \in \Omega$ (unit velocity)
$MinV_{tlk}(\omega)$	Minimum velocity en route between locations $l \in L$ and $k \in L: l \neq k$ in time period $t \in T$ , for scenario $\omega \in \Omega$ (unit velocity)
$PC_p$	Unit production cost for product $p \in P$ (€/batch)
$PC_{tp}$	Available production capacity at the plant for product $p \in P$ in time period $t \in T$ (batch)
$PRC$	Total available production resource capacity at the plant (total number of resources)
$PR_p$	Production resource utilization for producing one unit of production $p \in P$ (number of resources used/unit of product $p$ )
$Q_{tlp}$	Required demand from product $p \in P$ at location $l \in L$ for time period $t \in T$ (batch)
$S_{tp}$	Required Safety stock for product $p \in P$ in time period $t \in T$ (batch)
$u$	Emission factor for Greenhouse gas (CO <sub>2</sub> , CH <sub>4</sub> and N <sub>2</sub> O) resulting from mobile sources

**Decision Variables**

$X_{tp}$	Quantity of product $p \in P$ produced in time period $t$ (batch)
$Z_{tlk}$	$\begin{cases} 1 & \text{if the route of location } l \in L \text{ to location } k \in K, l \neq k, \text{ will be used} \\ & \text{in time period } t \in T \\ 0 & \text{otherwise} \end{cases}$
$H_{tlp}$	Quantity of ending inventory of product $p \in P$ kept at location $l \in L$ for time period $t \in T$ (batch)
$A_{tlp}$	Quantity of product $p \in P$ delivered to location $l \in L$ in time period $t \in T$ (batch)
$V_{tlk}(\omega)$	Vehicle velocity en route between locations $l \in L$ and $k \in L: l \neq k$ in time period $t \in T$ , for scenario $\omega \in \Omega$ (unit velocity)
$E_{tlk}(\omega)$	Total carbon emissions value en route between locations $l \in L$ and $k \in L: l \neq k$ , in time period $t \in T$ , for scenario $\omega \in \Omega$ (emission unit)
$OE_{tlk}(\omega)$	Total produced carbon emissions over the permissible limits en route between locations $l \in L$ and $k \in L$ in time period $t \in T$ , for scenario $\omega \in \Omega$ (emission unit)
$UE_{tlk}(\omega)$	Total produced carbon emissions under the permissible limits en route between locations $l \in L$ and $k \in L$ in time period $t \in T$ , for scenario $\omega \in \Omega$ (emission unit)

Given the previous problem definition, model dynamics, and notation, the resulting formulation is as follows:

$$\min \sum_{t \in T} \sum_{p \in P} PC_p \cdot X_{tp} + \sum_{p \in P} \sum_{t \in T} HC_p \cdot H_{tp} + \sum_{t \in T} \sum_{p \in P} DC_{lk} \cdot D_{lk} \cdot Z_{tlk} + E_\omega [Q(X, H, Z, \omega)] \quad [1]$$

**Subject to**

$$X_{tp} \leq PC_{tp} \quad \forall p \in P, \forall t \in T \quad [2]$$

$$\sum_{p \in P} PR_p X_{tp} \leq PRC \quad \forall t \in T \quad [3]$$

$$H_{tp} \leq IC_{tp} \quad \forall t \in T, \forall p \in P \quad [4]$$

$$\sum_{p \in P} IR_p \cdot H_{tp} \leq IRC \quad \forall t \in T \quad [5]$$

$$X_{1p} = H_{1lp} - H + S_{1p} + \sum_{l \in L} A_{1lp} \quad \forall p \in P \quad [6]$$

$$X_{tp} = H_{tlp} - H_{(t-1)lp} + S_{tp} + \sum_{l \in L} A_{tlp} \quad \forall p \in P, \forall t \in T \setminus \{1\} \quad [7]$$

$$\sum_{l \in L} Z_{tlk} = 1 \quad \forall k \in L \setminus \{1, l\}, t \in T \quad [8]$$

$$\sum_{k \in L} Z_{tlk} = 1 \quad \forall l \in L \setminus \{1, k\}, \forall t \in T \quad [9]$$

$$\sum_{p \in P} Q_{tlp} \leq \sum_{p \in P} A_{tlp} \leq CAP \quad \forall l \in L, t \in T \quad [10]$$

$$\begin{aligned} \sum_{p \in P} A_{tkp} &\geq \sum_{p \in P} A_{tlp} + \sum_{p \in P} Q_{tkp} - CAP + \\ CAP \cdot (Z_{tkl} + Z_{tlk}) &- \left[ \sum_{p \in P} Q_{tkp} + \sum_{p \in P} Q_{tlp} \right] \cdot Z_{tkl} \end{aligned} \quad \begin{aligned} \forall t \in T, \\ \forall k \in L \setminus \{1\}, \\ \forall l \in L \setminus \{1, k\} \end{aligned} \quad [11]$$



$$\sum_{p \in P} A_{tkp} \leq CAP - \left( CAP - \sum_{p \in P} Q_{tkp} \right) \cdot Z_{t1k} \quad \forall t \in T, \forall k \in L \quad [12]$$

$$\sum_{p \in P} A_{tlp} - \sum_{p \in P} Q_{tlp} - \sum_{p \in P} \sum_{i \in L \setminus \{1\}} Q_{tip} \cdot Z_{til} \geq 0 \quad \forall t \in T, \forall l \in L \quad [13]$$

$$\sum_{k \in L \setminus \{1\}} Z_{t1k} - 0.99 \geq \sum_{l \in L \setminus \{1\}} \frac{Q_{tlp}}{CAP} \quad \forall t \in T, \forall p \in P \quad [14]$$

$$Z_{tlk} \in \{0,1\} \quad \forall l \in L \quad [15]$$

$$X_{tp}, H_{tlp}, A_{tlp} \geq 0 \quad \forall l \in L, \forall t \in T, \forall p \in P \quad [16]$$

Where  $Q(X, H, Z, \omega)$  is the optimal value of the following second stage problem:

$$\min Q(X, H, Z, \omega) = \sum_{l \in L} \sum_{k \in L \setminus \{l\}} \sum_{t \in T} [(EM_{lk} \cdot B_{lk}) \cdot V_{tlk}(\omega) + F_{lk} \cdot OE_{tlk}(\omega) + G_{lk} \cdot UE_{tlk}(\omega)] \quad [17]$$

**Subject to**

$$\min V_{tlk}(\omega) \cdot Z_{tlk} \leq V_{tlk}(\omega) \leq \max V_{tlk}(\omega) \cdot Z_{tlk} \quad \forall t \in T, \forall l \in L, \forall k \in L \setminus \{l\}, \forall \omega \quad [18]$$

$$\sum_{l \in L} EM_{lk} \cdot V_{tlk}(\omega) = E_{tlk}(\omega) \quad \forall t \in T, \forall l \in L, \forall k \in L \setminus \{l\}, \forall \omega \quad [19]$$

$$OE_{tlk}(\omega) \geq E_{tlk}(\omega) - \max E \cdot Z_{tlk} \quad \forall t \in T, \forall l \in L, \forall k \in L \setminus \{l\}, \forall \omega \quad [20]$$

$$UE_{tlk}(\omega) \geq \min E \cdot Z_{tlk} - E_{tlk}(\omega) \quad \forall t \in T, \forall l \in L, \forall k \in L \setminus \{l\}, \forall \omega \quad [21]$$

$$OE_{tlk}(\omega), UE_{tlk}(\omega), V_{tlk}(\omega) \geq 0 \quad \forall t \in T, \forall l \in L, \forall k \in L \setminus \{l\}, \forall \omega \quad [22]$$

Where, objective function (1) minimizes the total costs of production, distribution and inventory for all productions across the whole planning horizon, in addition to the expectation of the second stage (recourse value) problem. Constraints (2) and (3) present the production capacity restrictions. Similar capacities are modeled for inventory quantities in constraints (4) and (5), respectively. Constraints (6) and (7) are the lot sizing constraints used to balance the total amounts produced with the quantities kept in inventory, safety stocks, and demand satisfaction.

Constraints (8) and (9) ensure that each location (except the depot) is visited exactly once in each time period. Constraint (10) sets the total quantities to be delivered at each location be greater than or equal to the demand and less than the capacity of the vehicle used in the delivery. Constraints (11), (12), and (13) are the route sequencing constraints. Constraint (14) secures enough vehicles to serve the assigned locations. Constraint (15) sets the binary restrictions for the first stage binary variables and constraints (16) are the non-negativity constraints for all first stage continuous variables.

The second stage objective function (17) minimizes the total costs associated with emissions, penalties for overage emissions (paid to the governments) and that for underage emissions (associated with delivery delays for customers). Constraint (18) ensures that the chosen velocity at each route in each time period at each scenario is between the realized minimum and maximum velocities on that route. That is if that route was chosen in the first stage. Constraint (19) calculates the total emission level of each chosen route. Constraints (20) and (21) calculate the overage or underage emission. Constraints (22) are the non-negativity constraints for the second stage variables.

We next apply our model to a real-world case study in the batch processes industry, and show the importance of integrating the different issues (production, distribution, green logistics represented by emission values) that our model includes.

## Conclusions and directions for future work

In this paper we proposed a green logistics oriented framework for integrated production-distribution in the batch processes industry. The considered environmental aspect is related to carbon emissions as a function of random vehicle velocities. The proposed model will be applied to a real-world case in the batch processes industry. There are many prospects for further research to this work. One is involving the green aspects in the production stage, rather than just in the distribution stage. A second addition could be using different emission estimation ways and comparing them altogether. A third extension is adding other sources of uncertainty, such as the production costs and capacities. A fourth and final direction could be calculating the effect of considering the social criteria such as improving labor conditions and human rights.

## References

- [1] Al-e-hashem, S.M.J.; Baboli, A.; Sazvar, Z.: A stochastic aggregate production planning model in a green supply chain: Considering flexible lead times, nonlinear purchase and shortage cost functions. In: *European Journal of Operational Research* 230 (2013) 1, pp 26–41.
- [2] Ageron, B.; Gunasekaran, A.; Spalanzani, A.: Sustainable supply management: An empirical study. In: *International Journal of Production Economics* 140 (2012) 1, pp 168–182.
- [3] Aronsson, H.; Brodin, M. H.: The environmental impact of changing logistics structures. In: *The International Journal of Logistics Management* 17 (2006) 3, pp 394–415.
- [4] Bidhandi, H. M.; Rosnah, M.Y.: Integrated supply chain planning under uncertainty using an improved stochastic approach. In: *Applied Mathematical Modelling* 35 (2011) 6, pp 2618–2630.
- [5] Birge, J. R.; Louveaux, F.: *Introduction to Stochastic Programming, Second Edition*. Springer, New York 2011.
- [6] Chen, Z.: Integrated production and distribution operations: taxonomy, models, and review. In: Simchi-Levi, D. et al. (Eds.): *Handbook of Quantitative Supply Chain Analysis: Modeling in the E-Business Era*. Kluwer Academic Publishers, 2004.
- [7] Cheung, R.K.-M.; Powell, W.B.: Models and algorithms for distribution problems with uncertain demands. In: *Transportation Science* 30 (1996), pp 43–59.
- [8] Daskin, M.S., Benjaafar, S., 2010. NSF Symposium final report. NSF Symposium on the
- [9] *Low Carbon Supply Chain*.
- [10] Dekker, R.; Bloemhof, J.; Mallidis, I.: Operations research for green logistics – An overview of aspects, issues, contributions and challenges. In: *European Journal of Operational Research* 219 (2012) 2, pp 671–679.
- [11] El-Berishy, N.: *An Advanced Production Planning and Scheduling System for Batch Process Industry*. LAMBERT Academic Publishing, 2011.
- [12] Fahimnia, B.; Luong, L.; Marian, R.: Optimization/simulation modeling of the integrated production-distribution plan: an innovative survey. In: *WSEAS Transactions on Business and Economics* 5 (2008) 3, pp 52–65.
- [13] Georgiadis, M.C.; Tsiakis, P.; Longinidis, P.; Sofioglou, M.K.: Optimal design of supply chain networks under uncertain transient demand variations. In: *Omega* 39 (2011) 3, pp 254–272.
- [14] Geotschalckx, M.; Vidal, C.; Dogan, K.: Modeling and design of global logistics systems: A review of integrated strategic and tactical models and design algorithms. In: *European Journal of Operational Research* 143 (2002) 1, pp 1–18.
- [15] Golver, F.; Jones, G.; Karney, D.; Klingman, D.; Mote, J.: An integrated production, distribution, and inventory planning system. In: *Interfaces* 9 (1979) 5, pp 21–35.
- [16] Ji, G.; Gunasekaran, A.; Yang, G.: Constructing sustainable supply chain under double environmental medium regulations. In: *International Journal of Production Economics* 147(Part B) (2014), pp 211–219.
- [17] Jouzdani, J.; Sadjadi, S. J.; Fathian, M.: Dynamic dairy facility location and supply chain planning under traffic congestion and demand uncertainty: A case study of Tehran. In: *Applied Mathematical Modelling* 37 (2013) 18/19, pp 8467–8483.
- [18] Long, Q.; Zhang, W.: An integrated framework for agent based inventory–production–transportation modeling and distributed simulation of supply chains. In: *Information Sciences* 277 (2014), pp 567–581.
- [19] NETCEN, National atmospheric emissions inventory: limiting speeds, 2006. URL: <http://naei.defra.gov.uk/reports/>, Date of access 15.03.2014.
- [20] Pinto-Varela, T.; Barbosa-Póvoa, A.; Novais, A.: Bi-objective optimization approach to the design and planning of supply chains: Economic versus environmental performances. In: *Computers and Chemical Engineering* 35 (2011) 8, pp 1454–1468.
- [21] Sazvar, Z.; Al-e-hashem, S.M.; Baboli, A.; Akbari Jokar, M.R.: A bi-objective stochastic programming model for a centralized green supply chain with deteriorating products. In: *International Journal of Production Economics* 150 (2014), pp 140–154.
- [22] Sheu, J.-B.; Chou, Y.-H.; Hu, C.-C.: An integrated logistics operational model for green-supply chain management. In: *Transportation Research* 41(Part E) (2005), pp 287–313.
- [23] Srivastava, S.K.: Green supply-chain management: a state-of-the-art literature review. In: *International Journal of Management Reviews* 9 (2007) 1, pp 53–80.
- [24] Stankovic, B.; Bakic, V.: Scheduling of batch operations– model based optimization approach. In: *Facta Universities: Mechanical Engineering* 4 (2006) 1, pp 83–92.
- [25] Ubeda, S.; Arcelus, F.J.; Faulin, J.: Green logistics at Eroski: A case study. In: *International Journal of Production Economics* 131 (2011) 1, pp 44–51.
- [26] Wang, F.; Lai, X.; Shi, N.: A multi-objective optimization for green supply chain network design. In: *Decision Support Systems* 51 (2011) 2, pp 262–269.
- [27] Zhang B.; Xu, L.: Multi-item production planning with carbon cap and trade mechanism. In: *International Journal of Production Economics* 144 (2013) 1, pp 118–127.
- [28] Zhu, Q.; Cote, R.: Integrating green supply chain management into an embryonic eco-industrial development: a case study of the Guitang group. In: *Journal of Cleaner Production* 12 (2004), pp 1025–1035.



## Nagham El-Berishy, M.Sc.

Email: elb@biba.uni-bremen.de  
 Country: Egypt  
 Start: 01.04.2011  
 Supervisor: Prof. Dr. Bernd Scholz-Reiter  
 Faculty: Production Engineering  
 Research Group: Planning and Control of Production Systems  
 Funded by: German Academic Exchange Service (DAAD) – GERLS

# Decentralized Resource Allocation for In-House Logistics

Christoph Greulich

**In autonomous in-house logistics systems, efficient allocation of services like transportation or storage space has high influence on the overall performance. Depending on the given system, agents have to compete for certain resources to reach their respective goals. To improve the throughput of a system, idle times have to be minimized and congestions have to be avoided. In some systems, dependencies between resources and time-uncertainties caused by human interference further increase the complexity of the resource allocation problems. Both multi-agent auction mechanisms and model predictive control have been successfully applied to solve resource allocation problems of various domains in a decentralized way. This research compares both approaches with regard to specific logistic systems.**

**Introduction >>>** In the last decades, the logistics domain had to meet new requirements caused by the introduction of Mass Customization and the ongoing success of e-commerce. More and more companies successfully implement Mass Customization [1] in order to reach the smallest possible markets by producing individual goods for individual customers [2]. Experts expect the logistics domain to grow even further due to advances in e-commerce and niche offerings [3].

The possibilities for Mass Customization are still restrained by the limits of assembly segmentation and lack of autonomy in supply chains [4]. Hence, the Future Project Industry 4.0 suggests that loosening those limitations and implementing autonomy in supply chains by applying Cyber-Physical Systems (CPS) [5] and the Internet of Things [6] will be the key enabler for the fourth industrial revolution [7].

Before autonomy can be implemented in production facilities and in-house logistics, several aspects have to be taken into consideration. Some authors already emphasized, that a trade-off between costs and benefits has to be managed [8]. Other authors suggest the consideration of energy consumption [9] and costs of active and idle machines [10]. Another factor is the speed and synchronization of each production step. It is likely that parameters and their weights vary between different facilities. Additionally, synergistic effects may emerge between the various factors.

Further considerable factors in modern production facilities and warehouses are safety issues regarding Human-Robot-Interaction (HRI) [11,12]. Since machines can hardly predict human behavior, most HRI setups in production facilities avoid cooperation between

humans and robots. Instead, HRI setups are restrained by physical barriers to keep employees out of the working range of a robot. Interaction between humans and robots is usually reduced to simple handover processes. <<<

## Towards Autonomy

In Artificial Intelligence (AI), autonomous entities which act on their own behalf are called "agents". Even though no unified definition of agents exists in the literature, most authors agree that agents are autonomous software programs with certain social abilities: agents can use sensors to perceive the world around them, use actuators to manipulate their environment and are able to communicate with other agents or even human users if necessary [13]. Agents use the perceived information to make decisions on their own and change the world around them to their advantage. The degree of autonomy an agent has is restrained by its software program. Hence, agents can be distinguished into categories from simple reflex agents to learning agents, based on their capabilities to make decisions [14]. The biggest advantage of agent technology in comparison to equation-based modelling is the capability of Multi-Agent Systems (MAS) to solve problems locally and react dynamically to occurring events [15].

During the last decade, MAS have been used to solve various problems of the logistics domain in simulation and application [16]. More specifically, research in the LogDynamics Lab successfully demonstrated how agent technology can be applied to a

real-world scenario of production logistics. Following McFarlanes definition of intelligent products [17], Ganji et al. developed an agent-based assembly system for several variants of an automotive tail-light [18].

Each tail-light consists of several components, some of them vary depending on the targeted type variant. The tail-lights are assembled at five workstations which are connected by a monorail network. Each station is dedicated to the assembly of one specific part of the tail-light: Electronics, two different types of light bulbs, rubber seals and three different types of diffusers. The setup is shown in figure 1. Each component is assembled by a human worker, who does not necessarily work at the same speed, which adds time uncertainties to the overall system. Furthermore, customer demand may change over time, which results in increasing or decreasing need for specific product variants.

To improve flexibility regarding these dynamics, each tail-light is represented by an individual software agent which makes decisions on behalf of the product. An autonomous shuttle transports each product along the monorail network to the next production step as requested by the product agent. After each production step, the agent decides if the currently targeted type variant is still the best choice. The decision making relies on fuzzy logic [19] and dynamically avoids congestions by requesting updates on the current waiting time from any targeted station. However, aside of the communication regarding the waiting time, the system does not include any inter-agent cooperation.

To the contrary, Kiva Systems LLC developed an agent-based autonomous pick-pack-and-ship warehouse system which does not rely on local decision making [21]. The Kiva system consists of autonomous robot vehicles which carry movable shelves through a warehouse. It was designed to increase the productivity of human pickers by taking the desired storage shelves to their respective picking station instead of forcing the pickers to walk through the warehouse. Each picking station has a computer which shows the orders which have to be fulfilled. Additionally, every station has a limited local buffer for the boxes required for its current packing tasks. As the buffer is limited in size, the amount of simultaneously handled orders is not necessarily limited by the number of orders but by the size of the boxes required to ship the items. As the autonomous robots deliver shelves to the packing station, the human picker takes the required items from the shelves and adds them to the respective shipping box. Furthermore, the Kiva system assists in refilling of the shelves. At dedicated refill stations, new products can enter the warehouse. The robots deliver shelves with empty storage space to the refill stations and human workers transfer items from their local buffer to the shelves.

When not in use by a packing station, the shelves are stored on a two-dimensional grid of parking spaces. Due to the layout of the warehouse, some spaces are closer to picking stations than others. Hence, each station may have different shelves with different products in close range. Figure 2 shows a schematic illustration of a possible layout of the Kiva system.

**Figure 1:** An agent-based assembly system for several variants of an automotive tail-light with five workstations (green) and several rotating switches (yellow). [20]



**Figure 2:** Schematic illustration of the Kiva system:

Robots (light-red boxes) move shelves from parking spaces (dark red) to the picking stations (grey).

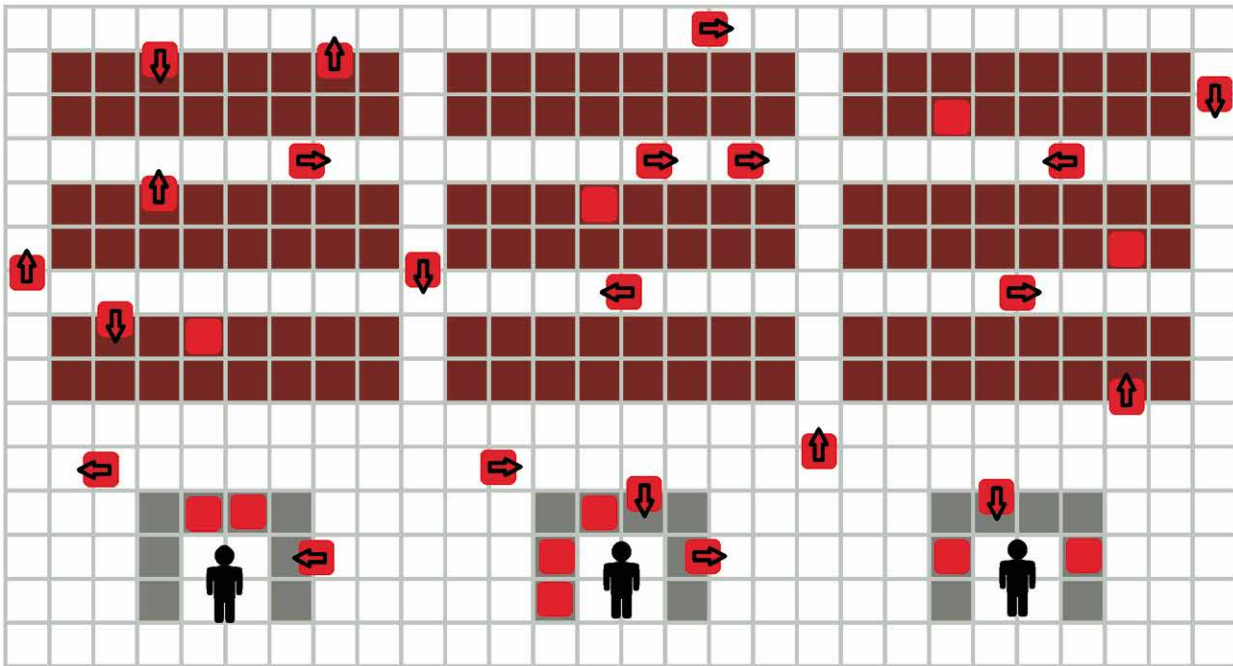

In the Kiva system, allocation of resources such as robots, pickers, orders and storage space is centralized in one dedicated agent. Hence, the autonomy of the remaining agents is limited to fulfilling their assigned tasks. However, the authors of the Kiva system expressed their interest in auction-based resource allocation [22] and emphasized the scientific value of their problem domain [23]. It is mentionable that Kiva Systems gained favourable interest by the online retailer Amazon.com, which eventually bought Kiva Systems LLC for 775 million US dollars [24]. Furthermore, G-Com, a similar warehouse system developed by Grenzebach Automation and Inconso AG, was recently deployed to a warehouse of BLG Logistics [25].

One of the key aspects in both scenarios is the efficient allocation of resources. In order to optimize throughput, it is mandatory to determine which order should be processed at which station and at what time. In both systems, stations with limited buffer capacity are operated by human workers with potentially unlimited time windows. Unlike most assembly line manufacturing systems, the various operational steps in the given systems are not synchronized. However, for optimal throughput, it is necessary to avoid congestions and idle times at stations.

For the Kiva system, resource allocation is even more complex. While the tail-light manufacturing system only allocates manufacturing stations to intelligent products, the Kiva system allocates packing stations to orders, robots to transportation tasks, and storage space to products. The high complexity of the allocation problem still leaves a lot of unanswered questions [23] and lead to the development of the Alphabet Soup test bed [26]. Alphabet Soup abstracts from the Kiva system and allows to explore allocation problems and multi-vehicle coordination on operational and tactical levels. Instead of shelves and products, the autonomous vehicles carry buckets of letters around, which will be combined to words at the picking stations. The simulation test bed allows scientists to focus on the problems regarding AI without concer-

ning hardware, physics, economics, product details or customer demand.

While both examples are applied to different domains, the systems share similar types of dynamics. In both systems, human interference causes time-uncertainty which influences the overall system performance. Additionally, both systems handle changing demand over time and use the robustness and flexibility of agent technology to decentralize the operational level but do not make use of the agent's cooperative potential on the tactical level.

## Decentralized Resource Allocation

The AI community developed a variety of solutions for inter-agent collaboration. A lot of these solutions are based on auction mechanisms where agents place bids on services or resources [27]. While most auction mechanisms rely on a centralized auctioneer, some solutions are implemented in a decentralized way [28].

Depending on the auction variant, agents can place bids on one specific resource provided by one specific agent or bid on the resource type without concerning a specific provider. In combinatorial auctions, agents can even place one bid on a specific combination of several resources offered by one or more providers.

However, even though a lot auction variants have proven their worth in theory and simulation, only few have been deployed to real-world systems. Complex negotiation mechanisms between agents are likely to generate communication overhead and become a bottleneck for the overall system, especially in large-scale scenarios. Additionally, depending on the real-world environment, background noises may influence communication and disturb auction protocols.

Zhang et al. [29] approached resource allocation from a different angle and adapted the Model Predictive Control (MPC) method to allocate resources for cloud computing. MPC is a

mathematical method to approximate optimal control in linear and nonlinear systems [30]. The MPC method uses the model of a system and its current state to predict future events within a given finite time horizon. Based on this prediction, an optimal control is computed and applied to the system. The process repeats as time progresses and the time horizon moves forward. Due to its iterative nature, MPC is capable of reacting to dynamic changes within the system. Furthermore, the method is capable of handling continuous and discrete time models.

Not unlike MAS, MPC can be applied in a distributed manner [31]. MPC controllers can solve problems locally or consider the planned input of other participants in the given scenario in their own optimization process. The model-based prediction and the local optimization of the MPC method clearly resemble the definition of utility-based agents according to Russell and Norvig [14]: utility-based agents make decisions based on a model of their environment and work towards an environmental state with high utility value.

The MPC method has been applied to a large number of problem domains. It is particularly useful for scenarios with short time windows for computing and can be implemented in hard-wired controllers. Therefore, it is heavily researched in the automotive industry. MPC was successfully applied to the simulation of car-to-car communication in traffic situations, where the participating cars cooperatively decide which car has the right of way [32]. In the given approach, neighbored cars are ordered hierarchically to simplify dependencies and communication complexity. The authors solve the problem successfully, however, they argue that the computation time of their solution is not yet fast enough for real-world deployment.

## Conclusion and Outlook

Both auctions and MPC have been successfully applied to resource allocation problems of various domains. However, both methods clearly have advantages and disadvantages which may make them more or less suitable for certain problems. The given examples of autonomous systems for in-house logistics both rely heavily on efficient resource allocation and share similar dynamics as both have to consider time-uncertainties caused by human interaction. This raises the question if both approaches are equally suitable to solve the given resource allocation problems or if a combination of both approaches is feasible to utilize the advantages of both approaches simultaneously.

## References

- [1] Fogliatto, F. S.; da Silveira, G. J.; Borenstein, D.: *The mass customization decade: An updated review of the literature*. In: *International Journal of Production Economics* 138 (2012) 1, pp 14–25.
- [2] Kaplan, A. M.; Haenlein, M.: *Toward a Parsimonious Definition of Traditional and Electronic Mass Customization*. In: *Journal of Product Innovation Management* 23 (2006) 2, pp 168–182.
- [3] Doll, A.; Friebel, D.; Rückriegel, M.; Schwarz Müller, C.: *Global Logistics Markets*. Barclays, Tech. Rep. August, 2014.
- [4] Günthner, W. A.; Wilke, M.; Zäh, M. F.; Rudolf, H.: *Planung von Produktionsprozessen und Materialflusssteuerung*. In: Lindemann, U.; Reichwald, R.; Zäh, M. F. (Eds.): *Individualisierte Produkte - Komplexität beherrschen in Entwicklung und Produktion*, ser. VDI-Buch. Springer, Berlin Heidelberg 2006, pp 151–161.
- [5] Broy, M.: *Cyber-Physical Systems (acatech diskutiert)*. Springer, Berlin Heidelberg 2010.
- [6] Fleisch, E.; Mattern, F. (Eds.): *Das Internet der Dinge – Ubiquitous Computing und RFID in der Praxis*. Springer, Berlin Heidelberg 2005.
- [7] Kagermann, H.; Wahlster, W.; Helbig, J.: *Umsetzungsempfehlungen für das Zukunftsprojekt Industrie 4.0. Abschlussbericht des Arbeitskreises Industrie*, 2013.
- [8] Piller, F. T.; Moeslein, K.; Stotko, C. M.: *Does mass customization pay? An economic approach to evaluate customer integration*. In: *Production Planning & Control* 15 (2004) 4, pp 435–444.
- [9] Liu, H.; Zhao, Q.; Huang, N.; Zhao, X.: *A Simulation-Based Tool for Energy Efficient Building Design for a Class of Manufacturing Plants*. In: *IEEE Transactions on Automation Science and Engineering* 10 (2013) 1, pp 117–123.
- [10] Hardin, A.; Zutty, J.; Bennett, G.; Huang, N.; Rohling, G. (2016): *Optimization of a Factory Line using Multi Objective Evolutionary Algorithms*. In: Kotzab, H.; Pannek, J.; Thoben, K.-D. (Eds.): *Dynamics in Logistics. Proceedings of the 4th International Conference LDIC*. Bremen, Germany 2014, in print
- [11] Vasic, M.; Billard, A.: *Safety issues in human-robot interactions*. In: *IEEE International Conference on Robotics and Automation*. Karlsruhe, Germany 2013, pp 197–204.
- [12] Martin-Guillerez, D.; Guiochet, J.; Powell, D.; Zanon C.: *A UML-based method for risk analysis of human-robot interactions*. In: *Proceedings of the 2nd International Workshop on Software Engineering for Resilient Systems (SERENE '10)*. 2010, pp 32–41.
- [13] Wooldridge, M.; Jennings, N. R.: *Intelligent agents: theory and practice*. In: *The Knowledge Engineering Review* 10 (1995) 2, pp 115–152.
- [14] Russell, S. J.; Norvig, P.: *Artificial Intelligence - A Modern Approach*, 3rd Edition. Pearson Education, 2010.
- [15] Parunak, H. V. D.; Savit, R.; Riolo, R. L.: *Agent-Based Modeling vs. Equation-Based Modeling: A Case Study and User's Guide*. In: Sichman, J. S.; Conte, R.; Gilbert N. (Eds.): *Multi-Agent Systems and Agent-Based Simulation (Lecture Notes in Computer Science) 1534*. Springer, Berlin Heidelberg 1998, pp 10–25.
- [16] Schuldt, A.: *Decentralisation and Interaction Efficiency in Cooperating Autonomous Logistics Processes*. In: Kreowski, H.-J.; Scholz-Reiter, B.; Thoben, K.-D. (Eds.): *2nd International Conference on Dynamics in Logistics*. Springer, Berlin Heidelberg 2011, pp 269–278.
- [17] McFarlane, D.; Sarma, S.; Chirn, J. L.; Wong, C.; Ashton, K.: *Auto ID systems and intelligent manufacturing control*. In: *Engineering Applications of Artificial Intelligence* 16 (2003) 4, pp 365–376.
- [18] Ganji, F.; Morales Kluge, E.; Scholz-Reiter, B.: *Bringing Agents into Application: Intelligent Products in Autonomous Logistics*. In: Schill, K.; Scholz-Reiter B.; Frommberger, L. (Eds.): *Artificial Intelligence and Logistics (AiLog) - Workshop at ECAI 2010*. 2010, pp 37–42.
- [19] Rekersbrink, H.; Ludwig, B.; Scholz-Reiter, B.: *Entscheidungen selbststeuernder logistischer Objekte*. In: *Industrie Management* 23 (2007) 4, pp 25–30.
- [20] Eicke, N.: *Verallgemeinerter Ansatz zur Simulation und grafischen Repräsentation von Produktionslogistikszenerarien mit Hilfe von PlaSMA*. Master thesis, University of Bremen 2015.

- [21] Wurman, P. R.; D'Andrea, R.; Mountz, M.: *Coordinating Hundreds of Cooperative, Autonomous Vehicles in Warehouses*. In: *AI Magazine* 29 (2008) 1, p 9.
- [22] Hazard, C. J.; Wurman, P. R.: *Representing Market Design Choices in Market-Oriented Programming*. Tech. Rep., 2007.
- [23] Enright, J.; Wurman, P. R.: *Optimization and Coordinated Autonomy in Mobile Fulfillment Systems*. In: *Automated Action Planning for Autonomous Mobile Robots: Papers from the 2011 AAAI Workshop*. AAAI Publications, 2011.
- [24] Kirsner, S.: *Amazon buys warehouse robotics start-up Kiva Systems for \$775 million, 2012*. URL: [http://www.boston.com/business/technology/innocent/2012/03/amazon\\_buys\\_warehouse\\_robotics.html](http://www.boston.com/business/technology/innocent/2012/03/amazon_buys_warehouse_robotics.html), Date of access 26.08.2015.
- [25] Beneke, M.: *BLG Logistics präsentiert europaweit einzigartiges Lagersystem, 2015*. URL: [http://www.weser-kurier.de/deutschland-welt\\_artikel,-BLG-Logistics-praesentiert-europaweit-einzigartiges-Lagersystem-\\_arid,1049612.html](http://www.weser-kurier.de/deutschland-welt_artikel,-BLG-Logistics-praesentiert-europaweit-einzigartiges-Lagersystem-_arid,1049612.html), Date of access 26.08.2015.
- [26] Hazard, C. J.; Wurman, P. R.: *Alphabet Soup: A Testbed for Studying Resource Allocation in Multi-vehicle Systems*. In: *Proceedings of the AAAI Workshop on Auction Mechanisms for Robot Coordination*. 2006, pp 23-30.
- [27] Shoham, Y.; Leyton-Brown, K.: *Multiagent Systems: Algorithmic, Game-Theoretic, and Logical Foundations*. Cambridge University Press, New York, USA 2008.
- [28] Dai, B.; Chen, H.: *A multi-agent and auction-based framework and approach for carrier collaboration*. In: *Logistics Research* 3 (2011) 2/3, pp 101–120.
- [29] Zhang, Q.; Zhu, Q.; Boutaba, R.: *Dynamic Resource Allocation for Spot Markets in Cloud Computing Environments*. In: *4th IEEE International Conference on Utility and Cloud Computing*. 2011, pp 178–185.
- [30] Grüne, L.; Pannek, J.: *Nonlinear Model Predictive Control: Theory and Algorithms*. Springer, London, UK 2011.
- [31] Rawlings, J. B.; Mayne, D. Q.: *Model Predictive Control: Theory and Design*. Nob Hill Publishing, LLC 2009.
- [32] Ritzhaupt, Y.; Geyer, H. R.: *Modellprädiktive Regelung in der Car-to-Car-Kommunikation*. Fakultät für Luft- und Raumfahrttechnik, Institut für Mathematik und Rechneranwendung, Universität der Bundeswehr, München, Tech. Rep., 2014



#### Christoph Greulich, Dipl. Inf.

Email: greulich@cs.uni-bremen.de  
 City, Country: Bremen, Germany  
 Start: 01.07.2013  
 Supervisor: Prof. Dr. Michael Lawo  
 Faculty: Mathematics / Computer Science  
 Research Group: Artificial Intelligence (TZI)  
 Funded by: University of Bremen



# IEEE 802.11p MAC Protocol Extension to Support Bandwidth Hungry Applications

Kishwer Abdul Khaliq

**Vehicular Ad hoc Networks (VANETs) have been a hot research topic for safety and entertainment applications. The IEEE 802.11p is one of the popular protocol for VANET, but it is less efficient for bandwidth hungry and delay sensitive applications, due to overhead of channel access, inter-frame spaces and acknowledgments. In this paper, we proposed an aggregation mechanism, Vehicular MAC Protocol Data Unit (V-MPDU) with block acknowledgement as an extension of IEEE 802.11p. The proposed aggregation technique collects frames against each destined node, wraps each frame in a single unit and permits each data frames to acknowledge individually. Hence, it improves the channel access mechanism, which ultimately reduces collisions, re-transmissions and improve bandwidth.**

**Introduction >>>** Vehicular Ad hoc Network (VANET) is a challenging domain in the wireless networks. VANET can be considered as off shoot of Mobile Ad hoc Networks (MANETs). IEEE recommends 802.11p as MAC and PHY layer standard to add wireless access in vehicular environments (WAVE)[1] [2] [3]. A vehicular communication system incorporates data exchange between high-speed vehicles (V2V) and between the vehicles and infrastructure (V2I) under licensed ITS band of 5.9 GHz (5.85-5.925 GHz).

In IEEE 802.11p, seven channels of 10MHz each, is available for transmission. There is one Control Channel (CCH) and six Service Channels (SCH) in IEEE802.11p [3][4][5]. All the safety applications use the CCH, whereas entertainment applications use the SCH. During the transmission of CCH, all the other channels stop their communication and listen to CCH. CCH can use SCH for its communications, but the SCH cannot use the CCH. IEEE 802.11p uses IEEE 802.11e priority mechanisms for QoS support [6] [7], as shown in Figure 1.

ITS initially gave the concept of safety applications, but the next generation ITS adds the use of bandwidth hungry applications, like Video on Demand (VoD), Voice over IP (VoIP), video conferencing, online gaming and file transfer, etc., which require less delay and high bandwidth. Currently, VANET focuses on safety application and uses IEEE 802.11p as MAC and PHY layer standard. At the MAC layer, IEEE 802.11p uses CSMA/CA for channel access. Research shows that IEEE802.11p performs good for safety application, but do not perform well for real time and bandwidth hungry applications in a vehicular environment [8] [9] [10] [6] [11]

[12]. Further, under heavy [13] traffic loads, there is performance degradation, both for individual nodes and for the whole network due to CSMA. In the worst case, packet drop was near to 80%. Therefore, it is unacceptable not only for safety applications, but also for bandwidth hungry applications. The authors have shown through simulations that in 802.11p, backoff window sizes are not adaptive and cause throughput degradation [14]. To handle this issue, in this paper, an aggregation mechanism Vehicular Protocol Data Unit (V-MPDU) with block acknowledgement as an extension of the existing IEEE 802.11p is proposed. V-MPDU aggregation collects frames to be transmitted to a single destination and wraps each frame in a single IEEE802.11p header. V-MPDU permits each of the aggregated data frames to be individually acknowledged or re-transmitted, in case of error. <<<

**Figure 1: IEEE 802.11p Channel Allocation [6]**

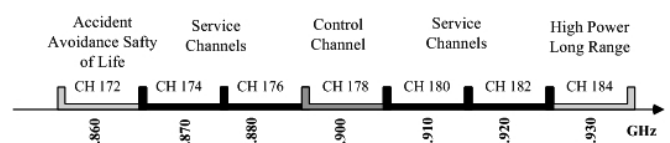

## Proposed extension for IEEE 802.11p

In Internet transmission, most of the packets are small in size that creates overhead specially for wireless networks. Current applications produce large number of small packets in a single burst, and there is significant fixed overhead of channel access, the inter-frame spaces and acknowledgments of each frame transmitted. Traditional MAC schemes do not handle such burst traffic and cause performance degradation in terms of throughput and delay. To reduce this overhead in VANET, a frame aggregation mechanism V-MPDU with block acknowledgement is proposed which transmits two or more frames of the same destination together into a single transmission. It improves the channel access mechanism in terms of efficiency as multiple frames are sent in a single transmission, which ultimately reduces number of potential collisions. Therefore, applications generating burst in VANET environment can be handle efficiently.

### a. Vehicular MAC Protocol Data Units (V-MPDU) with aggregation

Here, the structure of the V-MPDU is discussed. We have tried to design the simplest structure so that no extra overhead is generated. MAC PDUs are aggregated to produce a single V-MPDU. A delimiter is attached with each MPDU. An aggregated V-MPDU encapsulation is presented in Figure 2. A delimiter is designed of 24-bits in length i.e. 16-bits Size field and 8-bits CRC field. The 8-bits CRC field is for validate the integrity of the length of the header of MPDU. The receiver will parse the length field to de-capsulate the following MPDU. In case of corrupt delimiter, i.e. invalid length or CRC, receiver will discard the MPDU and move towards next MPDU. Here, multiple MPDU can be transmitted in a single channel access. Bandwidth hungry and delay sensitive applications which generate burst of small packets will not suffer more, as in a single channel access opportunity, multiple frames will be transmitted. A single PPDU is transmitted.

Figure 2: V-MPDU Encapsulation

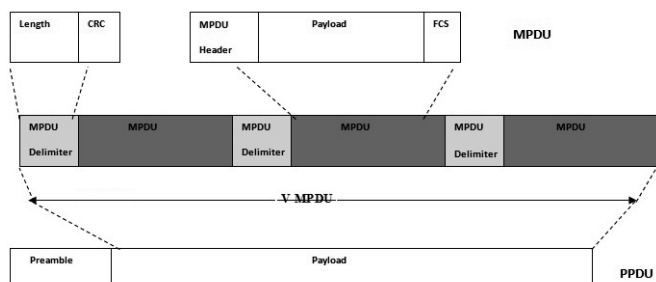

### b. Block Acknowledgment

IEEE802.11e introduced the Block Acknowledgment (BA) mechanism [15] i.e. a block of data is acknowledged with a single BA instead of sending acknowledgments for each frame. Block acknowledgement[16] [17] feature handles all the acknowledgments of the individual frames produced by V-MPDU aggregation into a single frame returned by the recipient to the sender. This allows implementation of selective re-transmission only for not acknowledged frames. In high erroneous environment rates, this selective re-transmission mechanism can provide some improvements in the effective throughput. Figure 3 depicts the Block Acknowledgment mechanism.

Figure 3: Block Acknowledgment for V-MPDU

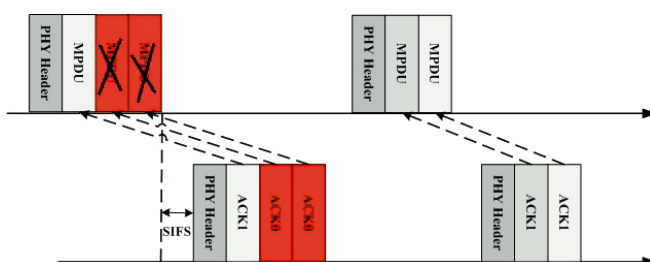

### c. Conditions for the V-MPDU

The purpose of V-MPDU is to combine multiple MPDUs under a single PHY header. Although there is no TID matching condition for the formation of V-MPDU but all the MPDUs in V-MPDU must have the same destination address. No waiting time is required for the formation of V-MPDU as it will take the available packets from the transmission queue. Padding bytes can be attached at the end of MPDU to make the size of MPDU compatible.

The default channel access mechanism of IEEE 802.11p is used for the channel access. Hence, a packet can be transmitted under two conditions

- A V-MPDU will be transmitted ,as a node gets the channel access i.e. it will collect all MPDUs from queue, make a V-MPDU and transmits,
- A V-MPDU will be transmitted, as the maximum size of V-MPDU is achieved.
- For emergency applications, the V-MPDU is optional

## Simulation and analysis

This section describes simulation setup used for the comparative analysis of IEEE 802.11p and IEEE 802.11p with V-MPDU. For the simulation, we have selected NS-2 which is an open source network simulator. For IEEE 802.11p simulation, we have used NS-2.34 which has a built-in support for IEEE 802.11p. For IEEE 802.11p V-MPDU simulation, we have used NS-2.34 and modified the A-MPDU code to V-MPDU.

The Table 1 describes parameters of simulation setup. Simulations are done in Linux distribution Fedora Core 9. Bandwidth is assumed as 27 Mbps for both IEEE 802.11p and IEEE 802.11p with V-MPDU. Constant-bit rate (CBR) traffic flows are used with UDP. Table 2 shows the parameters settings for IEEE 802.11p and IEEE 802.11 with V-MPDU.

**Table 1:** General Simulation Parameter

Operating System	Linux distribution Fedora Core 9
NS-2 versions	NS-2. 34
Radio-propagation model	Two-Ray-Ground
Bandwidth	27 Mbps
Traffic flows	Constant-bit rate (CBR)
CBR flow rates (Mbps)	Varies from 1-25 Mbps
Transport layer protocol	UDP
Number of nodes	Varies from 1-60

For analysis, we are using three metrics: goodput, average end-to-end delay and jitter. These three parameters are selected because of their significant role in estimating efficiency of real time and bandwidth hungry applications.

**Table 2:** Simulation Parameters Setting For Mac

Slot time	13 nano sec
SIFS interval	32 nano sec
Contention Window Min (CWMin)	15 slots
Contention Window Max (CWMax)	1023 slots

For comparative analysis, we have selected the following simulation scenarios

- Application traffic load
- Node density

**a. Application Traffic Load**

In this scenario, we compare the performance of IEEE 802.11p and IEEE 802.11 with V-MPDU for bandwidth hungry applications. The Table 3 gives the requirements for few bandwidth hungry applications.

**Table 3:** Bandwidth Hungry Applications

Applications	Bandwidth	Delay
High-Definition Telepresence	24 Mbps	50 msec
Telemedicine and Remote Surgery	10 Mbps	1 msec
Video Instant Messaging and Video Presence	10 Mbps	4 msec
High-Definition Television	8Mbps	
Real-Time Data Backup	2 Mbps	10 msec

For evaluation, we examine effect on goodput and delay by varying traffic loads. In this scenario, same bandwidth (27Mbps) is set for both IEEE 802.11p and IEEE 802.11p with V-MPDU, which is the maximum bandwidth value provided by IEEE 802.11p. Constant-bit Rate (CBR) traffic flows is used in the simulation with packet size of 1000 bytes which is kept constant. There are two other CBR flows of 500Kbps which acted as background traffic. 15-nodes are used in the scenario, which were moving at 100 Km/h. CBR traffic rate is varied to check its effect on goodput and packet delay at receiving node.

Bandwidth is considered as 27 Mbps for both IEEE 802.11p and IEEE 802.11p with VMPDU. The results are shown in Figure 4. Goodput increases with the increase in traffic load, which were varied as 1Mbps, 5Mbps, 10 Mbps, 15Mbps, 20Mbps and 25Mbps. Initially, both IEEE 802.11p and 802.11p with V-MPDU show increase in goodput. A constant goodput of 11Mbps is observed in case of 802.11p for traffic loads of 15Mbps, 20Mbps and 25Mbps. The

reason for this constant goodput is the bandwidth constraint of IEEE 802.11p. Therefore, goodput does not increase by increasing traffic load. Whereas, IEEE 802.11p with V-MPDU shows goodput of 19Mbps. IEEE 802.11p with V-MPDU performs well with increasing traffic load. This difference in goodput is due to IEEE 802.11p with V-MPDU MAC layer enhancements (frame aggregation and block acknowledgement). In the aggregation mechanism, different data packets are combined into one frame for transmission. Due to aggregation, overheads of header and backoff mechanisms are reduced because only one frame is transmitted instead of multiple frames. So it increases channel efficiency and results in high gain in goodput. The single block acknowledgement of the aggregated frame makes this aggregation mechanism more efficient. In the simulation, we have used block acknowledgement along with the aggregation mechanism.

Figure 5 shows end to end delay results for IEEE 802.11p and IEEE 802.11p with V-MPDU. It can be observed that for lower traffic load, delay is between 0 and 1 both for IEEE 802.11p and IEEE 802.11p with V-MPDU. By increasing traffic load, delay of IEEE 802.11p increases and after 10Mbps traffic load, delay becomes too large. The reason for this significant increase in delay is bandwidth constraint of IEEE 802.11p. When application is generating traffic with high rates, due to bandwidth constraint in IEEE 802.11p, packets in the buffer wait more which increase the delay. Whereas IEEE 802.11p with V-MPDU shows delay between 0ms and 1ms for all traffic loads. The reason is that, due to aggregation mechanism, overhead of the backoff mechanism and headers is reduced by transmitting a single frame which results in less average end-to-end delay.

**Conclusion and future work**

IEEE recommended IEEE 802.11p as the MAC and PHY layer standard for VANET. Our study shows that this standard is not suitable for infotainment applications in the scenario of urban areas where vehicles usually travel with the speed of 40 Km/h to 70 Km/h (time critical and bandwidth hungry applications). In this regard, an aggregation mechanism Vehicular MAC Protocol Data Unit (V-MPDU) with block acknowledgement as extension of the existing IEEE 802.11p is proposed. V-MPDU aggregation collects frames to be transmitted to a single destination and wraps each frame in a single IEEE 802.11p header. V-MPDU permits each of the aggregated data frames to be individually acknowledged or re-transmitted in case of error. Hence, it improves the channel access

**Figure 4:** Goodput Comparison with Different Application Traffic Loads

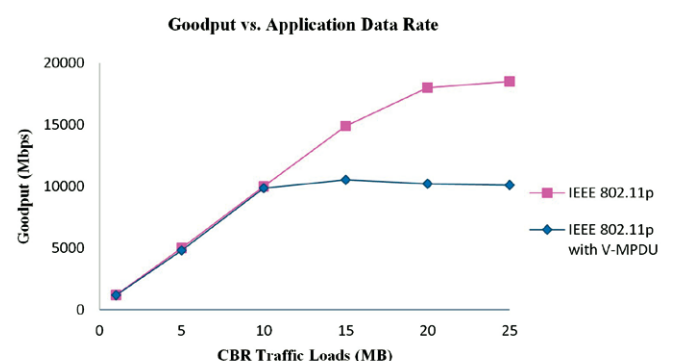

**Figure 5:** Average End-to-End Delay Comparison with Different Application

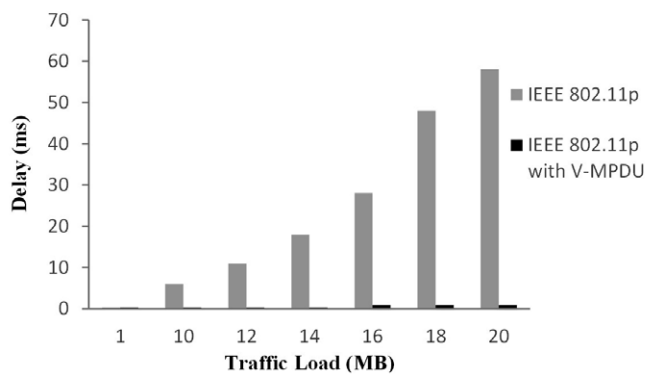

mechanism in terms of efficiency as multiple frames are sent in a single transmission which ultimately reduces number of potential collisions and re-transmissions as well. The proposed mechanism shows gain in bandwidth for IEEE 802.11p because of the more simulation scenarios proposed aggregation mechanism. Further, end-to-end delay also reduces. In this paper we present the initial simulation results. In the future, we will do a detail analysis by adding more scenarios.

## References

- [1] Amadeo, M.; Campolo, C.; Molinaro, A.: Enhancing IEEE 802.11 p/WAVE to provide infotainment applications in VANETs. In: *Ad Hoc Networks 10 (2012) 2*, pp 253–269.
- [2] Mohammad, S. A.; Rasheed, A.; Qayyum, A.: VANET architectures and protocol stacks: a survey. In: *Strang, T.; Festag, A. et al. (Eds.): Communication technologies for vehicles. Springer, Berlin Heidelberg 2011*, pp 95–105.
- [3] Dressler, F.; Kargl, F.; Ott, J.; Tonguz, O. K.; Wischhof, L.: Research challenges in intervehicular communication: lessons of the 2010 dagstuhl seminar. In: *Communications Magazine IEEE 49 (2011) 5*, pp 158–164.
- [4] Liu, B.; Khorashadi, B.; Du, H.; Ghosal, D.; Chuah, C.-N.; Zhang, M.: VGSim: An integrated networking and microscopic vehicular mobility simulation platform. In: *IEEE Communications Magazine 47 (2009) 5*, pp 134–141.
- [5] Murray, T.; Cojocari, M.; Fu, H.: Measuring the performance of IEEE 802.11 p using ns-2 simulator for vehicular networks. In: *IEEE International Conference on Electro/Information Technology. Ames, USA 2008*, pp 498–503.
- [6] Bilstrup, K.; Uhlemann, E.; Strom, E. G.; Bilstrup, U.: Evaluation of the IEEE 802.11 p MAC method for vehicle-to-vehicle communication. In: *IEEE 68th Vehicular Technology Conference, VTC 2008-Fall. Calgary, BC 2008*, pp 1–5.
- [7] Mangold, S.; Choi, S.; May, P.; Klein, O.; Hiertz, G.; Stibor, L.: IEEE 802.11 e Wireless LAN for Quality of Service. In: *Proceedings of the European Wireless. Florence, Italy 2002*, pp 32–39.
- [8] Morgan, Y. L.: Notes on DSRC & WAVE standards suite: Its architecture, design, and characteristics. In: *IEEE Commun. Surv. Tutorials 12 (2010) 4*, pp 504–518.
- [9] Wang, Y.; Zhang, Y.; Jiang, H.; Liu, J.; Wu, J.: An integrated propagation model for VANET in urban scenario. In: *Proceedings of the 6th International Wireless Communications and Mobile Computing Conference. ACM, New York, USA 2010*, pp 6–10.
- [10] Yang Y.; Bagrodia, R.: Evaluation of VANET-based advanced intelligent transportation systems. In: *Proceedings of the sixth ACM international workshop on VehiculAr InterNetworking. ACM, New York, USA 2009*, pp 3–12.
- [11] Choi, S.; Del Prado, J.; Sai Shankar, N.; Mangold, S.: IEEE 802.11e contention-based channel access (EDCF) performance evaluation. In: *IEEE International Conference on Communications, ICC'03(vol. 2). Anchorage, USA 2003*, pp 1151–1156.
- [12] Eichler, S.: Performance evaluation of the IEEE 802.11 p WAVE communication standard. In: *IEEE 66th Vehicular Technology Conference, VTC-2007 Fall. 2007*, pp 2199–2203.
- [13] Bilstrup, K.; Uhlemann, E.; Ström, E. G.; Bilstrup, U.: On the ability of the 802.11 p MAC method and STDMA to support real-time vehicle-to-vehicle communication. In: *EURASIP Journal on Wireless Communications and Networking (2009)*, pp 1–13.
- [14] Wang, Y.; Ahmed A.; Krishnamachari, B.; Psounis, K.: IEEE 802.11 p performance evaluation and protocol enhancement. In: *IEEE International Conference on Vehicular Electronics and Safety, ICVES 2008. Columbus, USA 2008*, pp 317–322.
- [15] Mangold, S.; Choi, S.; Hiertz, G. R.; Klein, O.; Walke, B.: Analysis of IEEE 802.11 e for QoS support in wireless LANs. In: *IEEE Wireless Communications 10 (2003) 6*, pp 40–50.
- [16] Brown, G. M.; Gouda, M. G.; Miller, R. E.: Block acknowledgment: Redesigning the window protocol. In: *IEEE Transactions on Communications 39 (1991) 4*, pp 524–532.
- [17] O'hara, B.; Petrick, A.: IEEE 802.11 handbook: a designer's companion. IEEE Standards Association, 2005.



**Kishwer Abdul Khaliq, M.Sc.**

Email: kai@biba.uni-bremen.de  
 Country: Pakistan  
 Start: 11.11.2014  
 Supervisor: Prof. Dr. Jürgen Pannek  
 Faculty: Production Engineering  
 Research Group: Dynamics in Logistics  
 Funded by: Erasmus Mundus programme cLINK of the European Union

# Model Development: for Analyzing Major Strategies and Issues of Supply Chain under Mass Customization

Arshia Khan

Many Industries have adopted the phenomena of mass customization, however, even within the same industry different companies adopt different strategies to manage their supply chain. There is no detailed study which deals with the comparative empirical analysis of different strategies and issues, adopted by different firms within the same industry. The purpose of this paper is to develop a complete model that not only evaluate issues and strategies of the supply chain while adopting mass customization, but also analyze the impact of customer value and mass customization on the company's financial performance. The resulted developed model will able to give a broader insight for future studies.

**Introduction >>>** There are many studies which deal with the comparative analysis of the supply chain of different industries, undertaking mass customization. Those studies have helped a specific industry to explore the problems which may hinder them towards application of mass customization [1]. However, there are very less works on the comparative analysis within the same industry, which can help to reveal the problems of some companies which have failed in adopting the mass customization strategy.

As a baseline, it is important to develop a model for the supply chain of customized products. There are several aspects which should be considered while analyzing mass customization. Two major difficulties in the implementation of mass customization are, (i) understanding the customer choice & preferences (ii) supply chain management [2].

There are few models which can evaluate the efficiency of the supply chain. However, there is lack of model that can give an explanation on how companies (belonging to same industry) should deal with different tools to manage their supply chain along with customization challenges. Furthermore, it is important to not only highlighting major issues in supply chain, but also emphasizing the importance of customer value and the optimal level of customization offered.

Taking this into consideration, the purpose of this paper aims at developing such a model for mass customized products that is not only addressing major issues in the supply chain, but also brings out the importance of customer satisfaction as well as the extent of customization. Development of such model can help to do a comparative analysis between different companies and give some insights on to typical problems in the supply chain. This model will try to incorporate some relevant variables that were ignored before.

Therefore, section 2 will explore the literatures in order to find out some important variables that deal with the development of model, section 3 will interpret model mathematically and section 4 will conclude this study along with some the suggestions for the future research. <<<

## Background

In order to develop a model which emerges some issues within the supply chain, optimal level of customization and importance of customer satisfaction, firstly it is important to identify how we can measure the supply chain efficiency or performance; section (a) will discuss this issue. Secondly, it is necessary to analyze how different tools of supply chain related to mass customization may impact the supply chain performance, for this purpose analysis of major variables will be done in the section (b). Furthermore, this paper will discuss the importance of customer satisfaction with respect to mass customization and supply chain, in section (c).

### (a) Measuring efficiency of supply chain

There are different indicators that can be used to evaluate the efficiency of the supply chain. An effort was made to measure supply chain efficiency in 1999 [3]. Three measures were investigated depending upon the area of focus. These three types include 1) output measures, 2) resource measures and 3) flexibility measures. Resource measures and output measures are most widely used measures, while flexibility measures have limited scope.

Profit is one type of measure that takes into accounts both resource and output measure. It gives a broader overview as it takes into account both sales and cost. So, using company's profit

as a measure can give a significant prospective, e.g. on how different variables are impacting not only supply chain but also the financial performance of the company.

### (b) Important problems in the supply chain

Successful supply chain management under any production processes depends mainly upon two main factors (1) the production planning or Inventory control process (2) Distribution and logistics process [4]. So, we will explore both of these issues in detail.

*Inventories issues:* A very important tool to achieve supply chain efficiency is management of inventory stock. To overcome the problem of inventory forecasting, companies (undertaking mass customization) are moving towards Just in time (JIT) inventory management. However, JIT demands very high and sophisticated relation with suppliers. The success of the JIT application mainly depends upon producers relations with the suppliers [5].

Almost all the companies undergoing mass customization are implementing JIT, but the extent to which JIT is implemented depends upon the company's relation and integration with their suppliers. This plays an important role in companies' inventory management policy. In a comparative study, analysis of three types of inventory stock related to 1) raw material 2) work in progress 3) inventory stock, can give an insight into the extent of implementation of JIT and inventory management related policies. The impact of this variable gives a clear insight into the company's success of implementing successful supply chain management policy.

*Distributional issues:* Distribution should ensure minimization of cost, time and complexity. To ensure an efficient distribution, it is important to have well defined supplier selection criteria [6]. One of the major criteria in supplier selection is supplier-buyer distance; this criterion has important implication on the logistics cost. However, there is very little work on this criterion. There is a study about nonlinear model that takes into account the distance between supplier and producer, it represents the total cost as a function of the supplier-buyer distance. The expected relation between these two criteria is positive [7]. However, there is no empirical testing of the relation and there is hardly any study which has empirically tested the results of this criterion. So, it is important to incorporate the effect of distances in the model. This distance will matter more if the amount of the product to be transported increase. If the distance is too much and the amount of product to be transported is also higher than it is better to shift either the production facility or the supplier. To take this into account, there is a need to develop a distribution distance index, which measures the overall distance in the supply chain along with the amount of product needed to be transported. Impact of such index on overall supply chain is an important criterion to measure supply chain efficiency.

### (c) Customer satisfaction and mass customization

Customer satisfaction has become more popular now; more companies have been considering giving importance to customer satisfaction. It is observed that the importance attributed to customer satisfaction by companies has been increasing trend, customer satisfaction was considered for strategic importance by 54% in 1988, 80% in 1991 and 96% by 1994 [8]. In the case of the automobile industry, customer satisfaction has impacted the customer repurchase behavior [9]. Mass customization is also carried out with the aim to satisfy more customers. However, it is very impor-

**Figure 1:** Structure for model

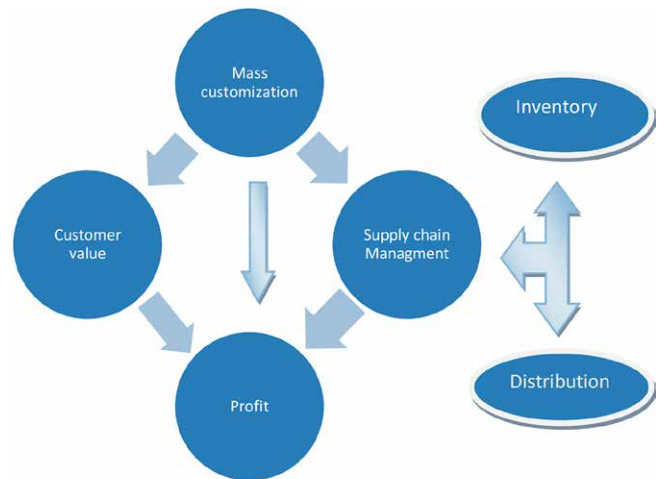

tant to consider that the customer needs more value instead of offering large variety of options [10]. It has also been observed that providing customers with large number of options to choose is not always preferable by customer, too many alternatives may confuse them instead of increasing their satisfaction level [11]. So, it has become important to evaluate the impact of customer satisfaction on companies' financial performance under mass customization. Thus, in order to evaluate the importance of customer satisfaction for mass customization, we have to consider how customer satisfaction is impacting financial performance of company (undergoing mass customization).

Moreover, it is also important to consider that how the extent of customization is affecting company's financial performance [12]. This can give insight to the question on what should be the optimal level of customization offered.

## Mathematical model for analysis

Considering profit, as a measure to analyze supply chain efficiency, has given us a broader prospect. We can not only see consider how distribution and inventory planning impact the supply chain efficiency, but also how customer satisfaction and extent of mass customization impacts the financial performance. Representation of a model is given in Figure 1. After analyzing all the aspects, we can consider profit (supply chain measuring instrument) as a function of supply chain distribution, inventory management, customer satisfaction and extent of mass customization. Combining above mentioned criteria's, in the formula gives us equation 1.

$$Y = f(I, MC, DD, CS) \quad (1)$$

Where

Y	=	Profit,
I	=	Inventories
MC	=	Extent of customization,
DD	=	Distributional distances,
CS	=	Customer satisfaction

Analyses of the equation (1) gives insight not only to the question on how the company's management of supply chain parameters (distribution and inventory management) is impacting the overall efficiency of supply chain, but also to a broader question on how the extent of mass customization is impacting profitability and what is the role of customer satisfaction in this regard.

## Conclusion

Mass customization is an increasing trend among many industries; it is thought to increase the customer value, but it creates more complexities in the supply chain. Many companies have failed in the phenomena, because of the lack of proper supply chain management. If in any industry, few firms are having benefits from this phenomenon, while other is facing losses, this means that then there is a need to investigate basic problems. To investigate such problems in the different companies among the same industry, there is a need to have a complete comprehensive empirical study. In this paper, we developed a comprehensive model for such study, in which the issues are identified within two main parts of the supply chain, i.e. inventory planning and distribution. Furthermore, the impact of mass customization and customer satisfaction on financial performance is analyzed. It is important to consider that supply chain efficiency is measured by profitability in the model, so it can give us a broader insight for analyzing the impact of the extent of mass customization and customer satisfaction on company's financial performance.

## Future suggestions

This study gives a complete model that is very complete in the regard that it is incorporating the issues of supply chain as well as considering customer satisfaction and mass customization are impacting the firm's financial performances. Future work is suggested can be done in the following area, such as:

- Investigation of the relation between customization and customer satisfaction
- Empirical analysis of the above mentioned model

## References

- [1] Pollard, D.; Chuo, S.; Lee, B.: *Strategies for mass customization*. In: *Journal of Business & Economics Research (JBER)* 6 (2008) 7, pp 77-86.
- [2] Åhlström, P.; Westbrook, R.: *Implications of mass customization for operations management: an exploratory survey*. In: *International Journal of Operations & Production Management* 19 (1999) 3, pp 262-275.
- [3] Beamon, B. M.: *Measuring supply chain performance*. In: *International Journal of Operations & Production Management* 19 (1999) 3, pp 275-292.
- [4] Uzorh, A.C.; Innocent, N.: *Supply Chain Management Optimization Problem*. *The International Journal of Engineering and Science (IJES)* 3 (2014) 6, pp 1-9.
- [5] Turnbull, P.; Oliver, N.; Wilkinson, B.: *Buyer-supplier relations in the UK-automotive industry: Strategic implications of the Japanese manufacturing model*. In: *Strategic Management Journal* 13 (1992) 2, pp 159-168.
- [6] Ware, N.; Sing, S.; Banwet, D.: *Supplier selection problem: A state-of-the-art review*. In: *Management Science Letters* 2 (2012) 5, pp 1465-1490.
- [7] Aguezzoul, A.; Ladet, P.: *A nonlinear multiobjective approach for the supplier selection, integrating transportation policies (2007)*. In: *Journal of Modelling in Management* 2 (2007) 2, pp 157 – 169.
- [8] Quelch, J. A., Kenny, D. (1994). *Extend profits, not product lines*. In: *Harvard Business Review*, 72(5), pp 153-160.
- [9] Huffman, C., Kahn, B. E. (1998). *Variety for sale: mass customization or mass confusion?* In: *Journal of retailing*, 74(4), pp 491-513.
- [10] Ernst & Young: *The International Quality Study*. Ernst & Young and the American Quality Foundation, New York, 1992.
- [11] Mittal, V.; Katrichis, J. M.; Kumar, P.: *Attribute performance and customer satisfaction over time: evidence from two field studies*. In: *Journal of Services Marketing* 15 (2001) 5, pp 343-356.
- [12] Bernhardt, D.; Liu, Q.; Serfes, K.: *Product customization*. In: *European Economic Review* 51 (2007) 6, pp 1396-1422.



### Arshia Khan, M.phil.

Email: arshia@uni-bremen.de  
 Country: Pakistan  
 Start: 07.12.2013  
 Supervisor: Prof. Dr. Hans-Dietrich Haasis  
 Faculty: Business Studies / Economics  
 Research Group: Maritime Business and Logistics  
 Funded by: Graduate School Scholarship Programme (GSSP), DAAD

# Enhancements for M2M Communication in Future Mobile Networks

Yasir Mehmood

Logistic processes such as fleet management and tracking of assets deeply rely on Machine-to-Machine (M2M) communication services. The concept of mobile M2M communication has emerged due to the wide range, coverage provisioning and decreasing costs of future mobile networks. Consequently, M2M traffic poses significant challenges to mobile networks especially due to the expected large group of devices with small data transmissions. This paper highlights various issues regarding resource utilization for M2M communication in LTE-A (Long-Term-Evolution-Advanced) networks. In this paper, a data aggregation scheme for the uplink M2M traffic is described and analyzed. In the proposed approach, radio resources are shared among various devices at the LTE-A Relay Node (RN). Furthermore, several solutions including smart handover and signaling procedures optimized for M2M communications are discussed.

**Introduction >>>** In recent years, research has achieved a significant importance for collaborative communication between numerous intelligent systems through either mobile or fixed networks. One of the resultant emerging domains is M2M communication. M2M communication is a pattern which identifies the evolving paradigm of interconnected devices communicating with each other without or with limited human interaction [1].

According to [1,2], the application area of M2M communications includes logistics, smart metering, e-healthcare, surveillance and security, intelligent transportation, city automation, smart monitoring and many more. For instance, in logistics the movements of the vehicles, containers, etc. are being tracked regularly through sensors which collect data of the location, vehicle speed, temperature, distribution progress, fuel consumption, etc. and send this information to the concerned application servers. Moreover, the goods which are transported from one place to another are monitored regularly in order to accomplish in time delivery and to handle any undesirable situation during shipment processes. Most of the goods are usually sensitive to several environmental changes such as temperature, light, humidity, etc. Therefore, in order to minimize such environmental effects, i.e., "Dynamics in Logistics", intelligent sensors are used to regularly monitor these parameters and frequently transmit this information to the backend servers. This brings significant improvements in the transportations and logistics processes [3]. Hence, M2M communications are indispensable for future logistics.

At the moment, current mobile standards such as GSM (Global System for Mobile Communications), UMTS (Universal Mobile Telecommunication System) etc. are providing services to distinct M2M applications. Moreover, the existing communication technologies offer low-cost deployment of M2M devices with roaming facilities. However, it is expected that the number of devices using M2M communications will grow exponentially. According to [4], the number of devices will reach 50 billion by the end of 2020. The current mobile standards are expected to run out of capacity and will not be able to support such a large number of devices. Consequently, M2M communication may not be facilitated proficiently in the cellular mobile networks.

Cellular standards such as LTE were particularly designed to support broadband H2H (Human-to-Human) traffic with a relatively small number of User Equipments (UEs) per cell. To achieve a high peak data rate and enable high mobility, the Third Generation Partnership Project (3GPP) introduced LTE-A in Release 10 with some modifications in Release 11 [5]. LTE-A is a recent 3GPP cellular standard, and is the technology that needs to support future M2M data traffic [6]. However, the dilemma is that M2M traffic patterns vary in diverse application domains. In most of the applications, sensor data is only a few bytes [7] [8]. In such cases, it is very difficult to achieve full spectrum efficiency. Therefore, it is essential to investigate methods and ways to utilize the limited radio resources among M2M devices efficiently [7]. <<<



## Standardization Efforts for M2M Communication

The major challenge concerned with M2M is to support a potentially large number of devices for which the LTE and LTE-A networks are not yet optimized. 3GPP has already started working on evolving LTE-A in order to integrate M2M communication more efficiently. Up to now, several open issues as well as a reference architectural model for M2M communications have been presented [9]. Recently, ETSI has also standardized the Low Throughput Network (LTN) which is a new network architecture with a set of protocols for future M2M communication [10]. Furthermore, IEEE has standardized 802.16p (i.e. Vehicular applications) and 802.16.1b projects to amend the existing standards to support future M2M traffic on a large scale. Major efforts related to cost and access schemes have been accomplished by two FP7 projects, namely EXALTED (EXpanding LTE for Devices) [1] and LOLA (Achieving LOW-LATency in Wireless Communications) [11]. Recently, METIS 2020 an ongoing EU project is also considering M2M as a front line research topic covering radio link challenges related to M2M in LTE-A [8].

## Problem Definition

The distinctive characteristics of M2M traffic pose serious challenges for cellular service providers as well as for mobile network researchers. The most challenging problem is the expected large number of small-sized M2M messages, as a huge number of devices are anticipated to be deployed in the near future. Moreover, it is also observed that in most M2M applications, the group behavior follows the one of the botnet (see [8]), as a large number of devices will access the networks simultaneously. Moreover, sev-

eral M2M applications such as logistics, intelligent transportation, and mobile e-healthcare also demand mobility support. Existing mobile standards are neither designed to handle small sized payloads efficiently nor to support simultaneous access of thousands of devices [8]. Consequently, this will lead to network congestion. The current mobile standards must be revised in order to support devices sending and receiving small sized data [6].

According to the 3GPP standardization, the smallest resource element for LTE is the Physical Resource Block (PRB) with a dimension of 180 kHz in the frequency domain and 1 millisecond in the time domain. According to present standardizations, the smallest unit of radio spectrum allocable to a single device is 1 PRB which is capable to transmit several thousands of bits under favorable channel conditions. For instance, 1608 bits are sent in a TTI with Modulation and Coding Scheme (MCS) of 16. However, allocating 1 PRB to a single M2M device will significantly degrade radio spectrum utilization due to the fact that M2M sensors mainly transmit and receive small data packets [8].

## Data Aggregation

In this section, the implementation and functioning of the data aggregation scheme for the uplink M2M traffic is described. In particular, this paper discusses the impact of data aggregation on the spectrum utilization for M2M communications in the uplink [Y. Mehmood, SNK. Marwat, Y. Zaki, C. G6rg, A. Timm-Giel, in 20 ITG Mobile Communication Conference. Evaluation of M2M Data Traffic Aggregation in LTE-A Uplink (VDE, Osnabr6ck, Germany, 2015), pp. 24–29]. Traffic from devices in proximity of an RN is accumulated by the RN before being sent to the donor eNB. In the proposed approach, small data packets are aggregated at the Packet Data Convergence Protocol (PDCP) layer of the RN in

Figure 1: High level illustration of the proposed M2M data traffic aggregation in LTE-A uplink

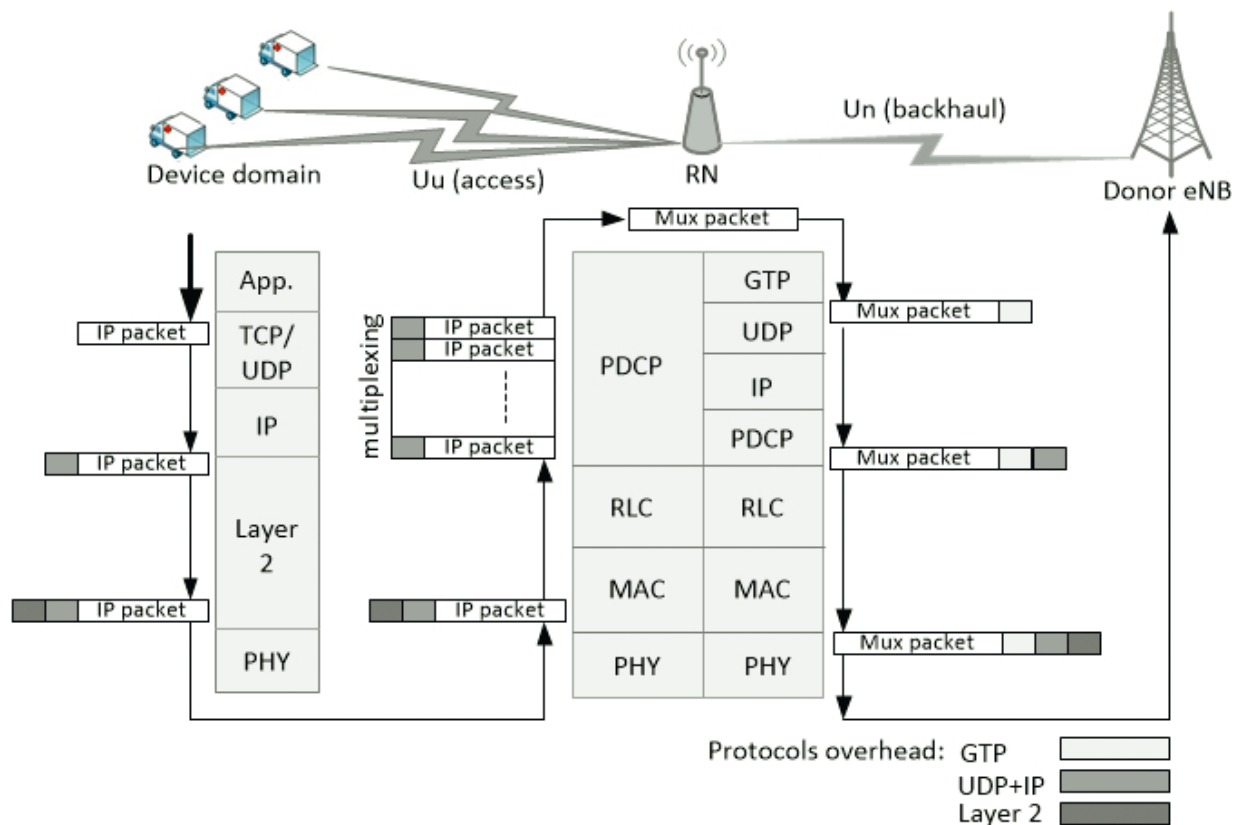

order to maximize the multiplexing gain without aggregating the additional headers, such as the PDCP, Radio Link Control (RLC) and Medium Access Control (MAC) (see Figure 1).

An aggregation buffer B is created at the PDCP layer of the RN, which aggregates the incoming packets according to the capacity of the available Transport Block (TB). The aggregated packet is sent to the RN GPRS Tunneling Protocol (GTP) at the backhaul (Un) link. The additional overheads such as the GTP, User Datagram Protocol (UDP) /IP and of layer 2 are added on the Un link. When the aggregated packet reaches the physical (PHY) layer, it is sent to the donor eNB.

This approach of multiplexing significantly improves the PRB utilization. However, there are certain constraints regarding latency requirements of high priority M2M traffic such as emergency alerting. Each packet waits till the size of the buffer B is equal to the available TBS. In a highly loaded scenario, the waiting time is not long due to a high arrival rate. However, in a low loaded scenario, there is a comparatively longer delay due to the low arrival rate. The performance of delay sensitive M2M applications, such as e-healthcare and emergency alerting, is degraded. To tackle this issue, an expiry timer  $T_{max}$  is introduced. The timer is set with a fixed value of 10 msec in the current implementation. This means that the buffer serves the aggregated packets after 10 msec at the latest. The value of the timer could also be adaptive, i.e. it can change its value adaptively according to the priority the incoming packets. For this purpose, the algorithm must be aware of various priorities of M2M applications.

The donor eNB receives the aggregated packet and de-multiplexing is performed at the GTP layer. The original small IP packets are sent to the back-end servers. A high level illustration of this setup is depicted in Figure 1.

## Simulation Setup and Results

The Optimized Network Engineering Tool (OPNET) Modeler is used as a primary modeling, simulation and analysis tool for this research topic. The OPNET Modeler provides a simulation environment for the performance measurements of communication networks [12]. The proposed data aggregation scheme is implemented in LTE-A model which is developed in the OPNET Modeler by the ComNets (Communication Networks) group, University of Bremen and University of Technology, Hamburg, Germany. The user movement in a cell is emulated by a mobility model which updates the location of the users. The user mobility information is stored in the global user database (Global-UE-List). The channel model parameters for the air interface include path loss, slow fading and fast fading models. In this paper, the simulation modeling mainly focuses on the user plane to perform end-to-end (E2E) performance evaluations. The OPNET simulations are performed under the parameter settings illustrated in Table 1.

The simulation results for the mean packet E2E delay and the number of PRBs used with 95% confidence intervals are illustrated in Figure 2 and Figure 3, respectively. The values of the upper and lower bound of the confidence intervals are very small in most of the scenarios as depicted in Figure 2. The simulation results clearly show efficient utilization of PRBs in the aggregated scenarios. For instance, in the “no multiplexing” scenario with 400 devices, the arrival rate at the PHY layer of the RN is 262.4 bits/TTI, which almost utilize 1 PRB. However, in the case of multiplexing, almost half of the PRBs is used to serve the 400 devices. Similarly, without

**Table 1:** Simulation parameters and traffic models

Parameter	Value
Simulation length	500 sec
eNB coverage radius	350 m
Min. eNB – UE distance	35 m
Max terminal power	23 dBm
System bandwidth	5 MHz (25 PRBs)
PRBs for RN	5 (uplink)
Terminal velocity	120 km/h
Mobility model	Random Way Point (RWP)
Frequency reuse factor	1
Timer, MCS, TBS & TTI	10 msec, 9, 1608 bits/TTI & 1 msec
Channel models	Pathloss, slow fading and fast fading
Pathloss	$128.1 + 37.6 \log_{10}(R)$ , R in km
Slow fading	Log-normal shadowing, correlation 1, deviation 8 dB
Fast fading	Jakes-like method [13]
<b>FTP traffic model</b>	
File size	10 Mbyte
File inter-request time	Constant (10 sec)
<b>M2M traffic model</b>	
Average message size	42 bytes at the PHY
Message inter send time	1 sec

multiplexing, the RN serves nearly 2500 devices with 5 PRBs in uplink. However, in case of multiplexing, the number of devices served by the RN is nearly doubles.

Moreover, in low loaded scenarios, the average number of PRBs used is slightly higher in the case of “multiplexing with timer”. This is due to the fact that the RN serves the traffic at the latest after 10 msec and thus the PRB is not necessarily used with its maximum capacity due to the low arrival rate. However, in high load scenarios, the timer has no impact and nearly equal numbers of PRBs are used with and without timer.

Similarly, Figure 3 depicts the simulation results of M2M mean packet E2E delay. The results show that the value of packet E2E delay increases due to multiplexing. This increase in delay is highly due to less number of arriving packets in low loaded scenarios. However, the use of an expiry timer reduces the delay by serving the aggregated packets at the latest after 10 msec. However, in the high loaded scenarios (e.g. 2000 devices), the E2E delay is slightly higher compared to the case of no multiplexing. This is due to high arrival rate and the buffer aggregates the incoming packets to make a large aggregated packet within less time. Moreover, the value of E2E delay is very large in fully loaded scenarios as depicted in Figure 3, when the RN utilizes all 5 PRBs with the maximum capacity.

Figure 2: Comparison of No. of PRBs used with and without multiplexing

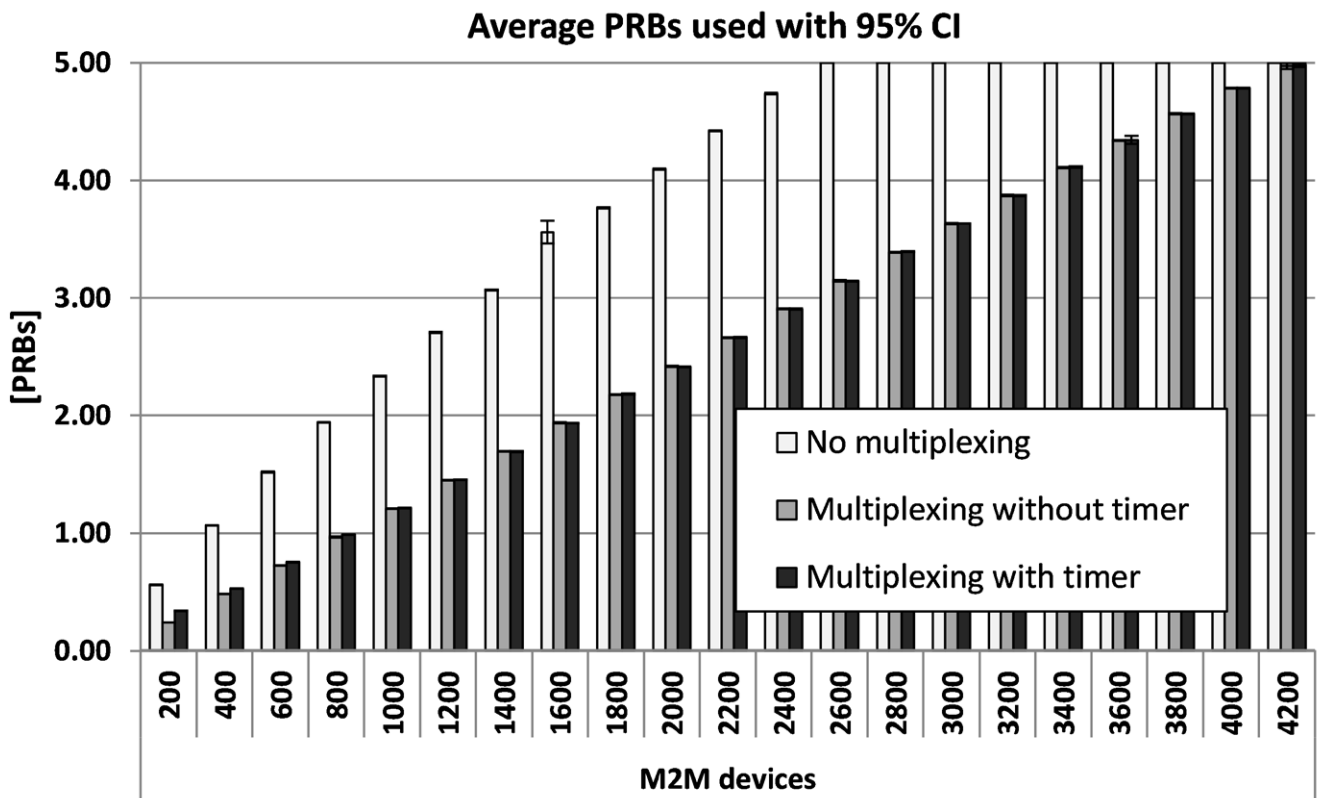
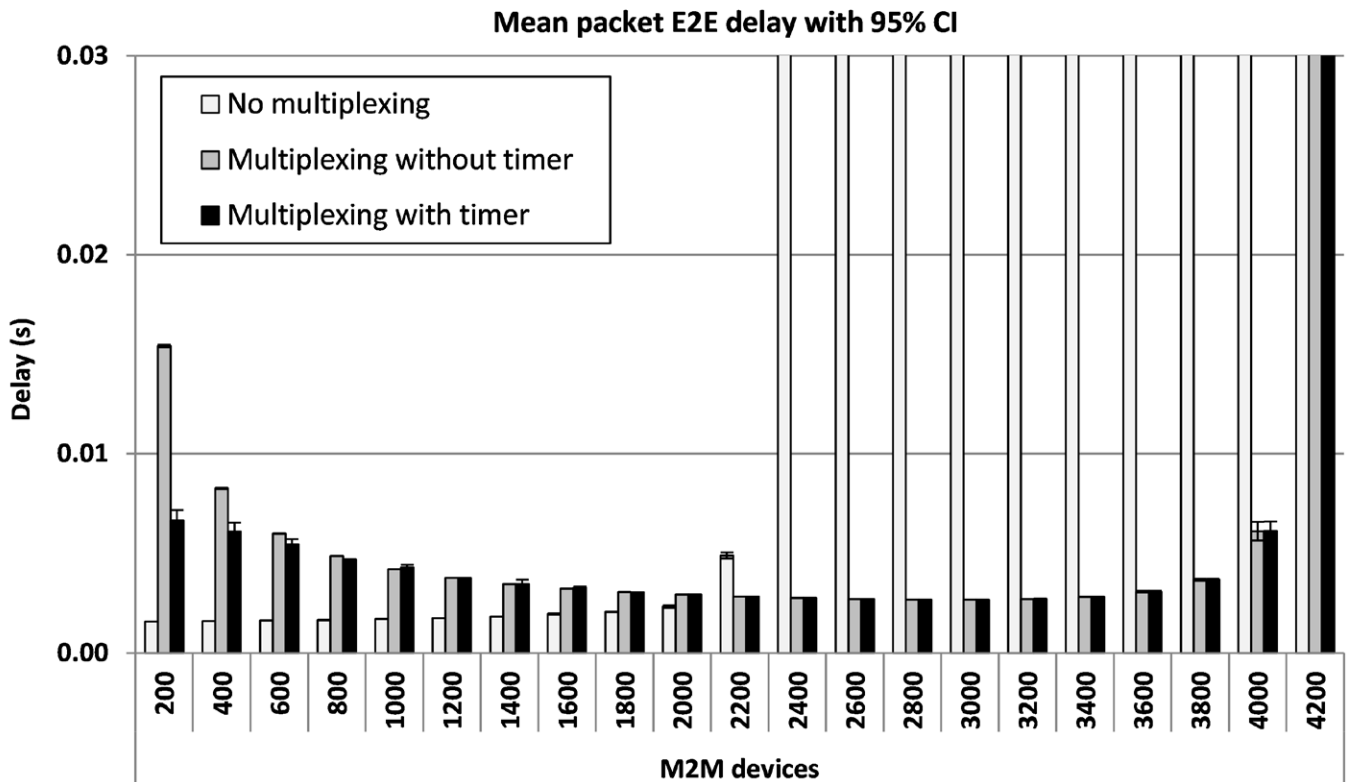

Figure 3: Comparison of mean packet E2E delay with and without multiplexing



## Conclusions and Outlook

Due to the limited bandwidth of mobile networks, rapidly growing M2M traffic is a major challenge for cellular service providers. Future M2M traffic might significantly degrade the performance of existing mobile networks. In order to support M2M traffic, efficient techniques such as data aggregation in uplink and downlink, smart handover procedure as well as signaling optimization might play a significant role. With the proposed approach, noticeable performance improvement in PRB utilization is achieved without introducing any new hardware complexity as RNs are one of the major LTE-A features. Given the simulation results reported in this paper, in the future recognizing narrowband M2M traffic could be a very important step for further bandwidth saving. Furthermore, the proposed scheme in this paper could be an efficient solution for handling this kind of traffic.

The current implementation of data aggregation does not take into account the Quality-of-Service (QoS) of various M2M applications. QoS provisioning is one of the major requirements of future M2M communication [6] [14]. In the future, it is planned to upgrade the proposed data aggregation scheme by categorizing M2M traffic into distinct classes. Due to the wide range of M2M applications, it is difficult to categorize M2M traffic into specific QoS classes. The QoS provision is possible using the existing 3GPP LTE-A traffic categorization. M2M applications such as e-healthcare and emergency alerting must be prioritized over applications, such as surveillance and regular monitoring.

Furthermore, it is planned to implement the proposed data traffic aggregation scheme for the downlink M2M traffic. In this case, the small packets will be multiplexed at the GTP layer of the donor eNB. It will be further investigated to de-multiplex the aggregated packets either at the RN or at the M2M device. However, the aggregated packets can be de-multiplexed at the RN in order to avoid sufficient losses. In this case, the individual packets will be sent to the respective M2M device by RN.

The LTE-A voice over IP (VoIP) traffic also consists of small packets compared to the FTP or video traffic. Therefore, multiplexing of the VoIP packets might also improve the radio resource utilization.

Moreover, to avoid signaling congestion due to the expected large group of devices, signaling aggregation and optimization will be investigated to significantly improve network performance. Furthermore, the existing handover procedures will be thoroughly investigated and a smart handover procedure will be designed to avoid network congestion. For this purpose, it is planned to use an RN which dynamically selects its serving eNB to offload the traffic of a loaded cell.

## References

- [1] Exalted (2013). URL: [http://www.ict-exalted.eu/fileadmin/documents/EXALTED\\_WP2\\_D2.1.pdf](http://www.ict-exalted.eu/fileadmin/documents/EXALTED_WP2_D2.1.pdf), Date of access 01.09.2015.
- [2] Cisco Systems Inc.: Cisco Visual Networking Index: Global Mobile Data Traffic Forecast Update, 2011-2016. Digital Publication, 2012.
- [3] ETSI: Machine-to-Machine (M2M) communication, use cases of automotive applications in M2M capable networks. Technical Report TR 102 898 V1.1.1, April 2013.
- [4] Ericsson: Towards 50 billion connected devices. Ericsson Discussion Paper, November 2010.
- [5] 3GPP: Carrier aggregation for LTE-Advanced. Release 11, September 2014.
- [6] 3GPP: Standardization of Machine-type Communications. M2M\_20140630, September 2014.
- [7] 3GPP: Service requirements for Machine-Type Communications (MTC). TS 23.368, December 2014.
- [8] METIS: Novel radio link concepts and state of the art analysis. Deliverable D2.2 ICT-317669-METIS/D2.2, 2013.
- [9] 3GPP: Technical Specification 23.888 V 11.0.0. (2012), System improvements for Machine-Type Communications. Technical Report, 2012.
- [10] ETSI: Low Throughput Networks (LTN); Protocols and Interfaces, 2014.
- [11] LOLA: Achieving LOw-LATency in Wireless Communications (2013). URL: <http://www.ict-lola.eu/>, Date of access 01.09.2015.
- [12] Riverbed: OPNET Modeler. URL: <http://www.riverbed.com/products/performance-management-control/>, Date of access 02.02.2015.
- [13] Cavers, J.K.: Mobile channel characteristics. Springer, 2000.
- [14] ETSI: M2M service requirements. Technical specifications TS 102 689 V1.1.1, 2010.
- [15] Y. Mehmood, SNK. Marwat, Y. Zaki, C. Görg, A. Timm-Giel, in 20 ITG Mobile Communication Conference. Evaluation of M2M Data Traffic Aggregation in LTE-A Uplink (VDE, Osnabrück, Germany, 2015), pp. 24–29



### Yasir Mehmood, M.Sc.

Email: ym@comnets.uni-bremen.de  
Country: Pakistan  
Start: 02.08.2014  
Supervisor: Prof. Dr. rer. nat. habil. Carmelita Görg  
Faculty: Physics / Electrical Engineering  
Research Group: Communication Networks  
Funded by: Erasmus Mundus programme FUSION of the European Union

# Enhancing the Product Life Cycle Information Feedbacks

Elaheh G. Nabati

**Advances in the data collecting and tracking technologies in the product lifecycle have faced organizations with large volumes of data. If properly analyzed, the knowledge extracted from these data can help organizations in the decision making process. The current research work investigates the possibility of integrating data analytics processes with the product middle of the life data for the aim of improving lifecycle activities e.g. how the data from the operation phase can help to improve maintenance activities. For this purpose, a conceptual framework for mapping and integrating the data analytics in the PLM is introduced. The applicability of this model is tested by means a case study on wind turbine's maintenance and operation. The results of the case study are represented as some recommendations for further improving the model.**

**Introduction >>>** Product lifecycle management (PLM) is a systematic approach to manage and integrate all activities and information related to a product and its extensions across its lifecycle [5] [14]. This cycle starts with the new idea development, continues by the design, realization, usage, maintenance and ends with the disposal of the product. These stages are usually categorized into three main phases; product's beginning of life (BOL), middle of life (MOL) and end of life (EOL). Logistics, operation and maintenance activities are located in the MOL stage [11]. A problem within the PLM process is that the captured information flows become weak after the product enters the usage and operation phase. This is because the data about the condition in which the product is operating or being used is usually not available [6]. This issue has been addressed recently and some advances have been made to track and collect product related data after it has entered the operation stage [9]. For example, technologies such as XML, RFID, PEID have been developed [7] [13] [2] [10]. But still there is a necessity to use the data which is collected and stored by these technologies in an effective way. Thus, there is a need to apply information analytics in PLM. Information analytics makes it possible to extract knowledge and insight from these data. This knowledge has the potential to improve the lifecycle activities. The extracted knowledge can be integrated afterwards as an information feedback from one phase of the product lifecycle such as usage phase to the other stages such as the maintenance phase. Although some research has been done to integrate information feedbacks into PLM [1] [3], still little attention has been paid on the data mining and data analytical perspectives.

In this research, application of data analysis in generating information feedback in PLM is investigated. The main focus is set on the product's middle of life, because information flows in BOL are nearly complete and new technologies mostly address the MOL. <<<

## Information management and modeling in PLM

The traditional data modeling system for PLM data is called Product Data Management systems (PDM). Before the emergence of PLM systems, product related data were collected by PDM. Various studies have been done to integrate the product related data to the PLM. First attempts to integrate PLM data to these IT based systems were reported by [14] [16]. Afterwards, numerous softwares and platforms were created to manage the life cycle data [9]. In the course of time, researchers added new components to PLM systems. For example, Xiao et al. (2010) presented a modeling framework for product lifecycle information. They focused on product lifecycle data sharing and managing with special consideration of simulating the product's prototype. Their approach was to add new product related fields such as product's shape, geometry and structure to IT solutions available for PLM. These specifications ease the collaborative design process [15].

Jun et al. (2007) provided a detailed overview of potential research areas in each phase of PLM. They concluded that by use of new information technologies such as sensors, RFID and smart

tags, the product lifecycle has converted to a closed loop. This means, the information of all phases such as MOL and EOL can now be identified, tracked and collected [6].

Abramovici et al. (2008) presented a concept for integrating the product use phase information into the PLM concept. They studied the possibility of incorporating condition monitoring (CM) data from the so-called usage phase into the development phase, in order to improve the next generation product design. They also studied the information feedback integration between these two phases [1].

From the data analysis perspective, Srinivasan (2011) presented a novel data integration framework for PLM. He stated that there is a need for new PLM models because of three existing and upcoming trends. First, the emergence of Meta data, second, the extension of products and the emphasis on service aspects besides the product itself, and third, the progress in technology which made middle-wares more robust [12].

None of the researches above addressed directly the question of how to analyze the data in PLM and to generate feedbacks. Hence, additional research in this area is necessary. This article

continues as follows: In the next section a holistic frame work for integrating information feed backs from the product use data is introduced and the limitations of this model is discussed. Afterwards, the results of a case study on wind turbines is presented. The last section provides the conclusion and future works.

## Extracting MOL information feedbacks

The overall frame work for generating information feedbacks from the use data and integrating this new information in the PLM is called PLIM (Product Lifecycle information management) systems is shown in figure 1. Data analysis is a part of this framework. It is referred to as the knowledge discovery system. Fathi and Holland (2009) developed this framework based on MOL data of Hydraulic pumps [4]. However, it is necessary to test the model it in another operational environment in order to evaluate its functionality and generalize it. Therefore, in this study a case study is done on wind turbines to investigate the applicability of this framework.

**Figure 1:** Overall PLIM framework for feedback MOL information to other PLM phases (adopted from [4])

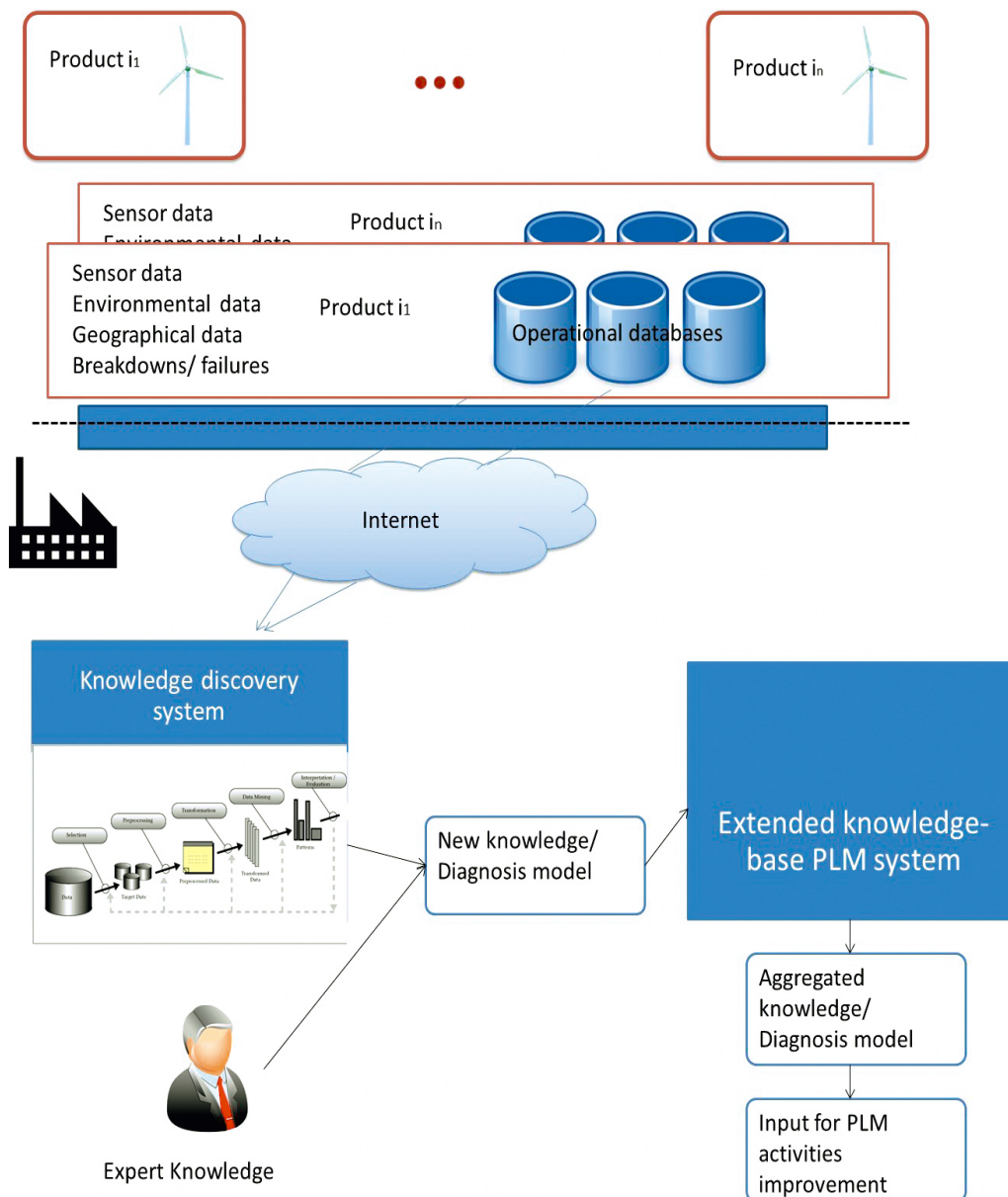

## Study on wind turbines

The estimated lifecycle of a wind turbine is 20 years. Maintenance activities of offshore wind turbines cause most of the costs through a turbine's whole life cycle. Thus, there is a high demand to reduce the maintenance and repair expenses and to improve the availability of this equipment. In order to understand how the mechanism of generating information feedbacks works and where the data analytics can be applied, a case study on the maintenance of wind turbines has been done.

In the case study, different processes during the MOL of wind turbine were specified. The data flows were identified and instances of gaining feedback were found. An example of a feedback flow is, the available information about a turbine's blade pitch angle is further analyzed [7]. The correlation between this angle and the pitch fault, which is the outcome of the analysis, can help the turbine's operator to better adjust the pitch angle and avoid the discontinuation of electricity production by the wind turbine.

Furthermore, this case study revealed some challenges of data analysis for wind turbine maintenance e.g. problems with sensor devices and issues to consider while doing the data analysis on the usage data. Based on the results of this wind turbine case study, the following points should be considered in the PLIM to further complete this framework (figure 1).

1. It is necessary integrate standard steps of data analysis in the PLIM framework. And during the analysis, it is important to consider not only the importance of data which is used in the analysis but also the importance of processes from where the data comes. The more risk the process has, the more important is the accuracy and the quality of the knowledge. For example, the process of dispatching the staff of personnel repair and maintenance in the off-shore wind turbines is more critical and contains more risks (in terms of time and cost). So, the data analysis for predicting the conditions in the case of offshore wind energy should be more reliable and accurate.
2. It is important to control and monitor the correct functioning of the collection devices such as sensors to reduce the production and transmission of incorrect data. Apart from the fact that incorrect input data result in poor quality diagnosis models, preprocessing of raw data usually takes the most time in procedure of data analytics. If the input data are incorrect and faulty, the preprocessing time will be doubled.
3. The aim of the analysis should be decided, otherwise the patterns found by the discovery techniques are either meaningless or imprecise. Moreover, data analytics expertise simply cannot or is unable to make up for a lack of domain knowledge. It is usually critical to have access to the domain experts to correctly understand the aim of the analysis.

By considering the following issues it is possible to test this framework and complete the modules.

## Conclusion

In this article the importance and the necessity of data analytics in the PLM was described. Several recommendations were given to complete the framework for integrating product feedback information in the PLIM. Based on a case study on wind turbines operation and maintenance, some challenges were identified which impact the knowledge discovery and data analysis system in the PLIM frame work (figure 1). In the future, these findings will have to be discussed in the PLIM model and solutions for feedback and knowledge extraction improvement recommended.

## References

- [1] Abramovici, M., Fathi, M., Holland, A., & Neubach, M. (2008). *Integration of Product Use Information into PLM*. 15th CIRP International Conference on Life Cycle Engineering, (S. 438-443). Sydney.
- [2] Cassina, J., Tomasella, M., Marquard, M., Metin, A., Matta, A., & Taisch, M. (2006). *Development of the semantic object model for a PDKM system*. International Conference on Concurrent Enterprising, (S. 383-390). Milan, Italy.
- [3] El Kadiri, S., Milicic, A., & Kritsis, D. (2013). *Linked data exploration in product life-cycle management*. IFIP Advances in Information and Communication Technology, S. 460-467.
- [4] Fathi, M., & Holland, A. (2009). *Knowledge-Based Feedback Integration to Facilitate Sustainable Product Innovation*. IEEE Conference on Emerging Technologies & Factory Automation.
- [5] Hadaya, P., & Marchildon, P. (2012). *Understanding product lifecycle management and supporting systems*. Industrial Management & Data Systems, 112(4), 559-583.
- [6] Jun, H.-B., Kiritsis, D., & Xirouchakis, P. (2007). *Research issues on closed-loop PLM*. Computers in Industry, 8-9, 855-868.
- [7] Kiritsis, D. (2004). *Ubiquitous product lifecycle management using product embedded information devices*. Proceedings of IMIS'04.
- [8] Kusiak, A., & Verma, A. (2011). *A Data-Driven Approach for Monitoring Blade Pitch Faults in Wind Turbines*. IEEE Transactions on Sustainable Energy, 2(1), 87-96.
- [9] Liu, W., Zeng, Y., Brisson, D., & Maletz, M. (2009). *Product lifecycle management: a review*. ASME international design engineering technical conference. San Diego, USA.
- [10] PROMISE. (2010). *Abgerufen am 2014 von The PROMISE project*: <http://promise-innovation.com/promise-plm>. Date of access 01.09.2015
- [11] Saaksvuori, A., & Immonen, A. (2005). *Product lifecycle management (2 Ausg.)*. Finland: Springer.
- [12] Srinivasan, V. (2011). *An integration framework for product lifecycle management*. Computer-Aided Design journal, 43(5), 464-478.
- [13] Srivastava, B. (2004). *Radio frequency id technology: the next revolution in scm*. Business Horizons, 47(6), 60-68.
- [14] Stark, J. (2006). *Product lifecycle management, 21st Century paradigm for product realisation*. London: Springer.
- [15] Xiao, S., Xudong, C., Li, Z., & Guanghong, G. (2010). *Modeling framework for product lifecycle information*. Simulation Modelling Practice and Theory, 18(8), 1080-1091.
- [16] Xin-sheng, X., Shui-liang, F., & Xin-jian, G. (2005). *A Framework for Product Lifecycle Management System*. 526-530.



### Elaheh Gholamzadeh Nabati, M.Sc.

Email: nab@biba.uni-bremen.de  
Country: Iran  
Start: 24.11.2013  
Supervisor: Prof. Dr.-Ing. Klaus-Dieter Thoben  
Faculty: Production Engineering  
Research Group: Collaborative Business in Enterprise Networks  
Funded by: Graduate School Scholarship Programme (GSSP), DAAD



# Massive M2M Communication in LTE Networks

Thomas Pötsch

**Machine-to-Machine (M2M) communication is one of the latest research areas and aims to enable machines to communicate with each other without human intervention. However, current cellular mobile networks, such as LTE, are designed and optimized for traffic characteristics of human-based communication, but M2M traffic is different: Packet sizes are small and transmitted periodically by numerous endpoints at the same time. In this paper, we focus on how LTE networks will handle the massive deployment of M2M devices. The authors specified an M2M traffic model that represents a possible logistical scenario in the future. Besides M2M traffic, also regular LTE traffic is present in the network and the influence of the increasing M2M traffic is investigated. The results of the simulations show that M2M traffic will influence regular, human-based traffic significantly.**

**Introduction >>>** Machine-to-Machine (M2M) communication is a world-wide, fast growing field of application and has a significant interest for many different devices and applications. Along with the growth of the variety and number of devices, also the mobile data traffic will grow significantly in the future [1]. In addition, the „Internet of Things“ is a new paradigm for devices that are becoming connected and M2M communication can be seen as an important part in this field of communication. According to [2], the „Internet of Things“ will extend the existing Internet with a variety of connected devices. In turn, also many application domains will benefit from this concept, for example supervision in logistical processes.

Besides the reason for an increasing interest in remote monitoring, such as health and environmental monitoring, also the maintenance costs of cellular networks experience a change: Cellular broadband connectivity became cheaper and ubiquitous over the past years, and also the costs of devices with integrated sensors, network interfaces, etc. are becoming smaller, cheaper and more powerful. That enables manufacturers to develop a variety of applications and devices, and new areas where those applications can be deployed.

Furthermore, Long Term Evolution (LTE) is expected to be the future technology to provide M2M services in mobile networks. The M2M applications are expected to offer a diverse range of services, including narrowband applications transmitting data infrequently. On the other hand, LTE is primarily developed for broadband data services and with narrowband applications, LTE cannot achieve spectrum and cost efficiency. Consequently, the integration of M2M communication, with their rather low data rates and small packet sizes, might have a considerable impact on the LTE system,

in particular on coexisting user. This paper illustrates the impact of M2M traffic on regular LTE traffic performance by comparing the simulation results of several scenarios. <<<

## Long Term Evolution (LTE)

LTE is the recent standard of wireless communication developed by the Third Generation Partnership Project (3GPP) to fulfill the data volume requirements of cellular mobile users. The objectives of LTE are to increase the peak user throughput, enhance spectral efficiency and reduce latency for broadband services. LTE has a packet-oriented transmission scheme and was originally designed to serve cellular devices with data rates of up to 100 Mbit/s [3].

The access network of LTE, the Evolved UMTS Terrestrial Radio Access Network (E-UTRAN), consists of two nodes; the eNodeB and the User Equipment (UE). In the radio access network, time and frequency resources are allocated to UEs by the Medium Access Control (MAC) layer scheduler of the eNodeB. The scheduler is generally designed to allocate resources for downlink and uplink transmission of regular LTE traffic according to the data buffer sizes of the UEs.

## Machine-to-Machine (M2M)

The term M2M communication refers to devices, so-called machines, with same or similar abilities to communicate with each other. The theme behind M2M communications is that the importance of machines increases when it is networked; while a network attains more worth when it interconnects more machines [4]. Existing M2M communications are currently based on contemporary wireless communication technologies like Global System for

Mobile communications/General Packet Radio Service (GSM/GPRS), which are fulfilling the requirements of existing M2M applications sufficiently. The contemporary communication technologies offer low-cost deployment of M2M devices with convenient deployment and roaming facilities.

Typically, those devices communicate over mobile or fixed networks to exchange data, such as sensor measurements. Although fixed networks still cover many application fields of M2M, cellular mobile networks are becoming more and more important in emerging M2M communication. Due to low-cost data-plans and the increased coverage of cellular networks worldwide, more and more devices are connected wireless.

Contrary to common end-to-end communications, M2M devices transfer its data without direct human intervention, i.e. autonomously. As a result, the generated traffic and the usage behavior is different to human-generated traffic.

## Traffic Characteristics of M2M

The characteristics of M2M traffic is different to existing, human-based network traffic. Where human-based communication obeys a certain session length, data volume and interaction frequency, M2M traffic follows some very specific traffic patterns. The most significant difference is the amount of data per transmitted packet: It is usually very small, i.e. only several (hundreds) bytes and refers to the nature of the generated data. As most of M2M devices are reporting sensor data, such as temperature readings, the transmitted packets consists of the measured data plus the corresponding protocol overhead. In general, this overhead is kept as small as possible, whereas the actual payload differs according to its application.

In most cases, a device reports the measured data in periodical intervals to a remote end-point. Although those intervals range from several minutes to hours [5] the multitude of distributed M2M devices within a certain cellular network may create a considerable dense scenario. However, also other devices with network connectivity are present at the same time.

According to [1], M2M traffic is expected to grow 22-fold from 2011 to 2016, which corresponds to an annual growth of 86 %. Following this expectation, by the end of 2012 this will result in an overall number of mobile-connected devices which exceeds the world's population (According to the U.S. Census Bureau [6], the total population of the world is projected as 7.055 billion by the end of 2012).

Although the most dominant devices will still be Smartphones and Personal Computers, such as laptops and notebooks, M2M devices will account for about 5 % of the total mobile data traffic in 2016. Even though they will still play a rather small role in the entire mobile data traffic, the average M2M device will generate 266 MB of traffic per month. That value corresponds to a data volume of approx. 6 kB per minute.

## M2M in Logistics

M2M communications are anticipated to have a strong impact on enhancing the standards of logistic processes. The storage period of goods, starting from departure at the source to arrival at the destination, requires monitoring of several environmental factors including temperature, pressure, humidity, light intensity and location, etc. Goods are usually sensitive to environmental changes and regular monitoring is required. Based on the sensor readings, it is required to take appropriate restorative measures and counter-

act unwanted situations. This can bring extensive improvement to the standard logistic processes. Hence, M2M communications can be vital for logistics in the future. In logistics industry, the delivery of goods with assurance of time, place, quantity and quality is of immense importance [7].

The most challenging issue faced by M2M communication is the expected large number of M2M messages in the future. M2M devices deployed in the transport vehicles, factories, and storage facilities to support logistic processes would transmit large number of messages. These M2M messages could have varying sizes and bandwidth requirements. M2M messages could be just a few bits in size, e.g., a simple temperature reading in a trailer. However, messages with a size of megabytes could also be expected, as in case of a video monitoring device. In LTE, the smallest resource unit that can be allocated to a device (or a UE) is the Physical Resource Block (PRB). A PRB has a dimension of 180 KHz in frequency domain and 1 millisecond in time domain. A PRB can transmit several kilobytes of data, if the radio channel conditions are favorable. In case a single PRB is allocated to an M2M device which transmits small messages, the spectral efficiency of LTE system could decline severely.

In cases of emergency like fire and flood, LTE network may have to deal with simultaneous transmission of emergency messages. This can cause severe degradation of the networks performance and blockage of resources for regular users. For example, in case of fire in a warehouse, simultaneously resource requests would be triggered by the building and vehicle alarms. The M2M messages could also have varying Quality of Service (QoS) requirements. The matter of fulfilling these QoS requirements is also a challenging problem and will not be discussed here.

In [8], an example for an implementation of an M2M protocol in transport logistics has been shown. In this project, the goods of a cargo-container are equipped with several sensors to acquire the environmental conditions. A supervision unit collects the measured data from the sensors and reports the aggregated set of measurements over a telematic device to its corresponding remote station periodically. Although a single dataset of an individual sensor can be considered as small (approx. 230 bytes), the aggregated dataset results in several kilobytes and is dependent on the number of sensors and the measured data itself.

## Simulation Parameters and Traffic Models

The modeling methodology behind the simulation model was mainly to focus on the user plane; so as to be able to perform end-to-end performance evaluations. The model was developed using the OPNET simulation environment [9]. The OPNET simulations are performed under the parameter settings illustrated in Table 1. More detail description of the LTE simulation model can be found in [10], [11].

Since M2M traffic requires uplink radio resources, the LTE uplink scheduler proposed in [13] is used for resource allocation without utilizing the search tree algorithm. The performance of different M2M traffic load scenarios is compared by analyzing the QoS performance of mobile devices with regular LTE uplink traffic. The simulations are carried out by considering three types of LTE traffic, i.e., voice, video, and file transfer; and one M2M traffic type.

The regular LTE traffic load is kept constant and the M2M traffic load is varied in the scenarios. In all scenarios, the number of voice, video, and file transfer users is 10 each. In the first scena-

**Table 1:** Simulation Parameters

Parameter	Setting
Cell Layout	1 eNodeB, 3 Cells
System Bandwidth	5 MHz (~25 PRBs)
Frequency Reuse Factor	1
Cell radius	375 m
UE velocity	120 km/h
Max UE power	23 dBm
Path loss	$128.1 + 37.6 \log_{10}(R)$ , R in km
Slow fading	Log-normal shadowing, 8 dB standard deviation, correlation 1
Fast fading	Jakes-like method [12]
Mobility Model	Random Way Point (RWP)
UE buffer size	Infinity
Power Control	Fractional PC, alpha = 0.6 P0 = -58 dBm
Traffic environment	Loaded
<b>Voice traffic model</b>	
Silence/ talk spurt length	Exponential (3 s)
Encoder scheme	GSM EFR
<b>Video traffic model</b>	
Frame size	1200 byte
Frame inter-arrival time	75 ms
<b>File transfer traffic model</b>	
File size	20 MB
File inter-request time	Uniform distribution, min 80 s, max 100 s
<b>M2M traffic model</b>	
Message size	6 kB
Message inter-transmission time	60 s

rio, there are no M2M devices (or trailers), whereas in the second scenario, 300 devices are deployed in the cell. The number of devices is incremented by 150 in the subsequent scenarios. During the simulations, the velocity of mobile devices deployed in the cell is 120km/h.

## Results and Analysis

The simulations results of LTE regular traffic users are depicted from Figure 1 to Figure 3. The video users and voice users results do not reveal a considerable effect of the increasing M2M traffic load within the LTE cell. The reason behind this is the fact that the LTE scheduler [12] gives strict priority to delay sensitive traffic like voice and video, hence no effect is observed. Now looking at the best effort traffic, like file transfer, one can start noticing that the impact of the M2M load is quite significant. Figure 1 clearly illustrates that increasing the M2M load drastically degrades the performance of the file transfer users. Even in scenarios with small LTE traffic, M2M traffic is already causing hindrance.

The overall cell QoS performance is depicted in Figure 4. The performance of delay sensitive traffic remains the same in most of the scenarios. However, the best effort traffic performance in terms of QoS deteriorates with increasing the M2M load. The average delay of file upload can increase from 231.3 sec to 249.6 sec despite very little LTE traffic in the network.

The M2M traffic model used in our simulations depicts a possi-

ble future logistic scenario with each device demanding resources to transmit 6 kbytes of data every 60 sec. In Figure 5, a comparison of a „near future“ traffic model of 4 kbytes and a „far future“ model of 8 kbytes with our traffic model is depicted. The graph illustrates that the expected growth in number of devices in the future would result in deterioration of QoS performance of regular LTE traffic.

Now, since the expectation over the next years shows that the M2M traffic load will only grow bigger, the load on the network would be significantly high and the LTE network operators have to cope with severe challenges, like, for example, how to differentiate between the human based traffic and the M2M traffic or how to guarantee the QoS for the human based traffic. The solution would require the LTE operators to change their scheduling mechanisms in a way that guarantees both the human traffic quality and the M2M requirements.

**Figure 1:** Average File Upload Time of File Transfer Users

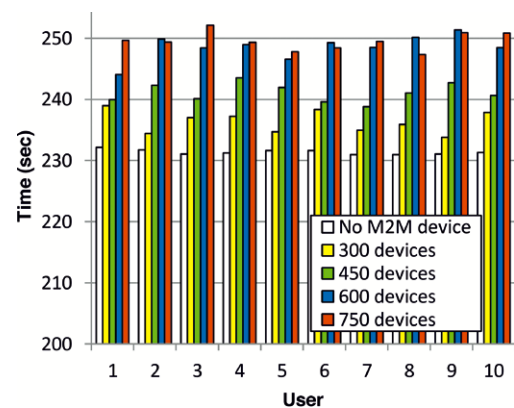

**Figure 2:** Average Packet End-to-End Delay of Voice Users

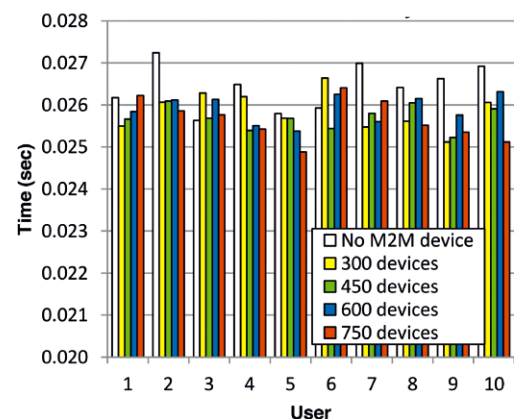

**Figure 3:** Average Packet End-to-End Delay of Video Users

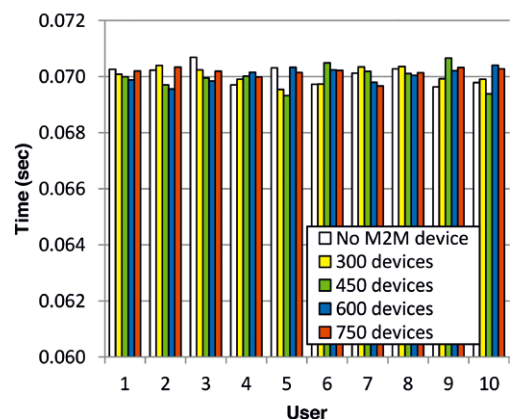

**Figure 4:** Cell QoS Performance Comparison with Varying M2M Load

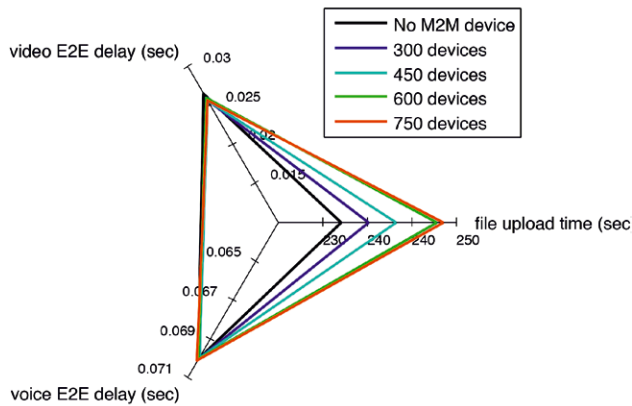

**Figure 5:** Comparison of M2M Traffic Models in Terms of Average Cell File Upload Time

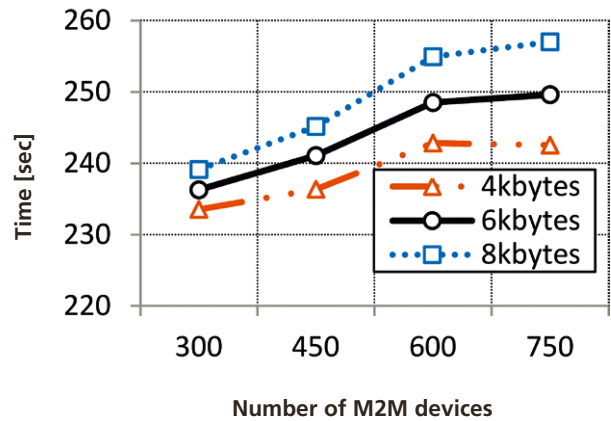

## Conclusions

In this paper, a feasibility study was performed to highlight the impact of the new and challenging topic of M2M communication within the cellular LTE network. Although LTE has been designed to provide high bandwidth, it is not proven how LTE handles the massive deployment of M2M communicating devices.

In contrast to the fact that the M2M traffic might seem small and its impact on current wireless communication systems might be negligible, we have demonstrated in this paper that the M2M traffic (although small) does have a big impact on the LTE network. Within the coming years, network operators are confronted with the problem of the increasing M2M traffic, hence it will influence the normal human traffic. Even though the performance of video and voice users remains unaffected by the additional M2M traffic, file upload experiences a considerable delay.

## References

- [1] Cisco Systems Inc.: Cisco Visual Networking Index: Global Mobile Data Traffic Forecast Update, 2011-2016. Digital Publication, Feb. 2012.
- [2] Coetzee, L.; Eksteen J.: The Internet of Things - Promise for the Future? An Introduction. In: Proceedings of the IST-Africa Conference. Gaborone, Botswana 2011.
- [3] 3GPP: Requirements for Evolved UTRA and UTRAN. v 2.1.0. Technical Report TR 25.913, Jun. 2005.
- [4] Lawton, G.: Machine-to-Machine Technology Gears up for Growth. In: Computer 37 (2004) 9, pp 12-15.
- [5] Shafiq, M. Z.; Ji, L.; Liu, A. X.; Pang, J.; Wang, J.: A First Look at cellular Machine-to-Machine Traffic: Large Scale Measurement and Characterization. In: Proceedings of the 12th ACM SIGMETRICS/PERFORMANCE Joint International Conference on Measurement and Modeling of Computer Systems. London, England, UK 2012, pp 65-76.
- [6] U.S. Census Bureau: World Population Statistics, 2012. URL: <http://www.census.gov/popclock/>, Date of access 10.09.2015.
- [7] Scholz-Reiter, B.; Mehraei, A.; G6rges M.: Handling the Dynamics in Logistics-Adoption of Dynamic Behavior and Reduction of Dynamic Effects. In: AIJST-Asian International Journal of Science and Technology Production and Manufacturing Engineering (AIJSTPME) 2 (2009) 3, pp 99-110.
- [8] Kuladinithi, K.; Bergmann, O.; P6tsch, T.; Becker, M.; G6rg, C.: Implementation of CoAP and its Application in Transport Logistics. In: Proceedings of the Workshop on Extending the Internet to Low power and Lossy Networks (IP+SN 2011). Chicago, IL, USA 2011.
- [9] OPNET Modeler. [Online]. Available: <http://de.riverbed.com/products/performance-management-control/>, Date of access 10.09.2015.
- [10] Zaki, Y.; Weerawardane, T.; G6rg, C.; Timm-Giel, A.: Long Term Evolution (LTE) Model development within OPNET Simulation Environment. In: OPNET Workshop 2011. Washington D.C., USA 2011.
- [11] Zaki, Y.; Zahariyev, N.; Weerawardane, T.; G6rg, C.; Timm-Giel, A.: Optimized Service Aware LTE MAC Scheduler: Design, Implementation and Performance Evaluation. In: OPNET Workshop 2011. Washington D.C., USA 2011.
- [12] Cavers, J.: Mobile Channel Characteristics. In: The Kluwer International Series in Engineering and Computer Science. Kluwer Academic, 2000.
- [13] Marwa, S. N. K.; Weerawardane, T.; Zaki, Y.; G6rg, C.; Timm-Giel A.: Performance Evaluation of Bandwidth and QoS Aware LTE Uplink Scheduler. In: Koucheryav, Y. et al. (Eds.): Wired/Wireless Internet Communication 7277. Springer, Berlin Heidelberg 2012, pp 298-306.



**Thomas P6tsch, M.Sc.**

Email: thp@comnets.uni-bremen.de  
 Country: Germany  
 Start: 01.05.2012  
 Supervisor: Prof. Dr. rer. nat. habil. Carmelita G6rg  
 Faculty: Physics / Electrical Engineering  
 Research Group: Communication Networks  
 Funded by: University of Bremen

# From Textual Instructions to Virtual Actions – A Case Study

Himangshu Sarma

**Interpreting textual instructions is a difficult task. In our case study we look at exercise instruction sheets and their interpretation and find out a way to interpret textual instructions to an embodied understanding. In this article we have developed a framework to interpret textual descriptions to virtual actions in order to eventually create an automated model.**

**Introduction >>>** Today games are the most popular tool for health and educational research. Where exergames are a type of video game which is used specially in health related categories, e.g. physical activity, fitness etc. The reasons behind of use of exergames for health conscious are because: (1) exergames do not require an exercise partner or sighted guide to be present, (2) exergames are performed in places, where minimize the risk of injury, (3) the possibility to play the same games as their peers or together with their peers or family, may increase socialization, (4) easy access to exergames significantly increases their existing exercise opportunities [1].

Transforming physical therapy exercises into computer-supported playful exercises in the form of so-called exergames or levels of exergames requires a lot of time and effort. Therefore, it is impractical for therapists or smaller practices to transform their preferred sets of therapeutic exercises into exergames, which can be used by their patients. <<<

## Motivation

During our study, we found that if someone wants to do some exercises, they typically do it by two ways: either from an instruction sheet or with the help of a Physiotherapist. In the case using the instruction sheet, it can only provide rough guidance and no feedback, which may lead to wrong or even harmful exercises, and also have a number of known limitations [2]. Physiotherapists are expensive and not always available nearby. So, if we can design an animated version of the exercises from the instruction sheets, then they might face fewer problems and have a better experience while doing the exercises.

## Steps to Solution

Firstly, we need to match the position of a virtual human skeleton to the instruction sheet's image, either by using automation or human computing (crowd sourcing). If through crowd sourcing, secondly we will try to transform human skeleton into instruction image, and from those different solutions, we can find an average solution on how to transform the human skeleton into instruction sheet's image. At last, with the help of a Physiotherapist and the results obtained from the crowd sourcing, we will try to give a best output result of the exercise, which might help the people to perform the exercise correctly.

## Future Work

In the next step, we will try to collect some data from Kinect and try to analyze them in order to make an automated model from physical exercise instruction sheet to virtual reality. The exergames are used as our first test scenario. In the future, we will try to explore in a much broader area, which will also cover logistics, e.g. packaging different goods automatically from package instructions.

Figure 1: Steps to solution

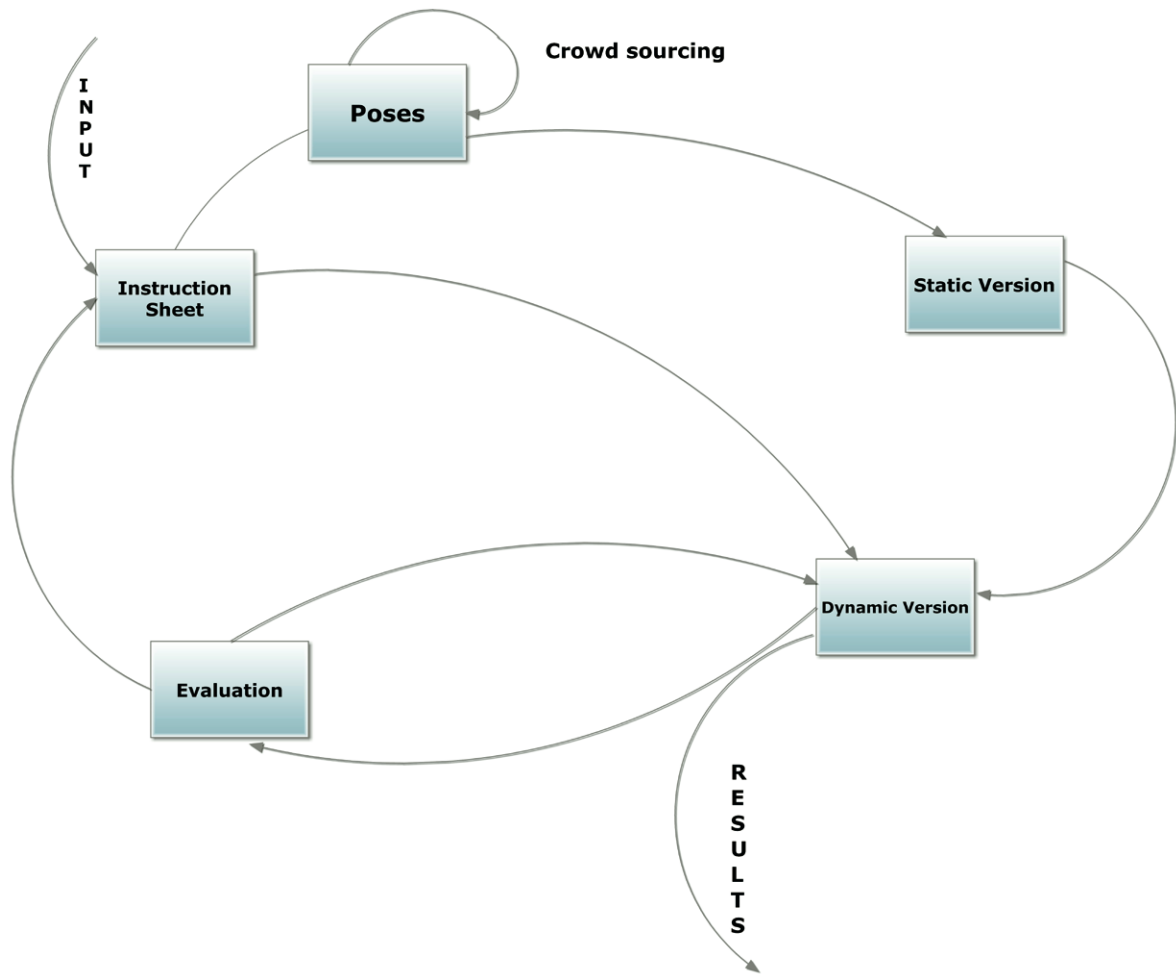

## References

- [1] Morelli, T.; Foley, J.; Columna, L.; Lieberman, L.; Folmer, E.: VI-Tennis: a vibrotactile/audio exergame for players who are visually impaired. In: *Proceedings of the Fifth International Conference on the Foundations of Digital Games*. ACM, New York, USA 2010.
- [2] Uzor, S.; Lynne, B.: Exploring & designing tools to enhance falls rehabilitation in the home. In: *Proceedings of the SIGCHI Conference on Human Factors in Computing Systems*. ACM, New York, USA 2013.



### Himangshu Sarma, M.Tech

E-mail: sarma@uni-bremen.de  
Country: India  
Start: 29.07.2014  
Supervisor: Prof. Dr. Rainer Malaka  
Faculty: Mathematics / Computer Science  
Research Group: Digital Media (TZI)  
Funded by: Erasmus Mundus programme cLINK of the European Union

# Scope of Computer Vision Techniques for the Detection of Microbial

M. Waseem Tahir

**Fungus is always a problem for human health and food logistics. Several techniques are used to reduce this threat, but when we consider food in large volume, e.g. containers of food, then these techniques miss the mark. They require labor, time and costly equipment for the detection of fungus. So, more reliable and convenient methods are required. In this article, we reviewed recent important development and application of computer vision techniques for the detection of microbial contamination in the food.**

**Introduction >>>** Optical microscopy was invented over 400 years ago [1]. Since then it is used in many fields like Medicine, Biomedical, Food sciences, etc. Researchers have worked very hard and made many improvements in basic microscope to see substances which are impossible to see with human naked eye. In recent years, one of the variations was the use of a camera as an eyepiece. This variation has also opened the door of computer vision in the field of microscopy. Now, we can record images which are seen by microscope, then further analyze it on computer and we can also improve those pictures with the help of computer vision techniques.

One third of the produced food is wasted [2]. Scientists around the world are focusing to minimize the food loss. Recently researchers have started using computer vision to detect microbial contamination in food products. Before that, research community has observed microbial elements through microscope. We accept that the results are more reliable, precise and effective. But this becomes a hectic task, when we talk about containers of food. When the volume is big, then it is impossible to have highly trained professionals, who can perform these tasks. Thus, we assume potential of inaccurate results. So the application of computer vision in this field is highly effective. <<<

## Detection of Microbial Using Computer Vision Techniques

Currently many techniques are used for the detection of microbial contamination in food products. These techniques are applied on color images, Multispectral images, Hyperspectral images, X-ray images and Thermal images. Some of the important works which are based on these techniques are showed in Table 1 and discussed in rest of this section.

Siripatrawan et al [3] proposed a Hyperspectral Imaging detection approach for the detection of *Esherichia coli* contamination in packaged fresh spinach. They used hyperspectral imaging camera with spectrum of 400–1000nm and a spectral resolution of 5nm. Principal Component Analysis (PCA) was applied to reduce the wavelength variables. The Artificial Neural Networks (ANN) was used to analyze the pre-processed data. ANN was also used to construct prediction map which allows rapid interpretation of the hyperspectral images.

Firrao et al [4] presented an approach for the fast response which is based on multispectral image analysis. They took images of a maize sample 10 times. They used 10 LEDs of different wavelengths between 720 to 940nm for the illumination. The comparative indexes were computed from matrices of image data. Then mycotoxin content was predicted from the calculated index through trained three layers feed forward neural network.

Kheiralipour et al. [5] developed a new threshold based classification method. They used thermal images of healthy and fungal infected pistachio kernels for diagnostic purposes. Features like maximum, mean, minimum, standard deviation, coefficient of

variation, median and mode were used. First, they took features then found maximum and minimum of each feature. Then, they calculated threshold for each class. In next step, they compared input with all thresholds. On the basis of these comparisons, they made decision.

Chelladurai et al [6] also used infrared thermal imaging system for the identification of fungus in stored wheat. They used Linear Discriminant Analysis (LDA) and Quadratic Discriminant Analysis (QDA) for classification. First, they placed heat samples and then heat them for 180s at 90 degree centigrade. Afterwards, they cool them down for 30s. During this period, they took 3 images. 1: before heating, 2: after heating, 3: after cooling. From these images, they calculated mean, maximum, minimum, median, mode and standard deviation of the surface temperatures of the grain. The change in temperature (rise and drop) of fungus infected grains is different from healthy grains.

Jirsa et al. [7] developed a discrimination model for the detection of Fusarium on wheat kernels. They took images of kernels from digital camera with dark background. Then, they applied different shape and color descriptors and finally developed a model using linear discriminant analysis.

## Conclusion

Currently computer vision techniques are used in food logistics for detection of microbial. However, the shortage of food increases awareness of food losses, which demands more sophisticated, reliable and cost effective methods. As discussed in this paper, the analysis of large food volumes using computer vision techniques can minimize the food losses in a cost effective manner.

**Table 1:** Computer Vision techniques used for microbial detection

Paper	Image Acquisition Device	Computer Vision Technique	Detection
Siripatrawan (3)	CCD Camera	Principal component analysis + Artificial neural network	Esherichia coli
Firrao (4)	Digital video camera	Feed forward neural network	Fumonisin
Kheiralipour(5)	ULIR Thermal Imaging camera	Threshold based classification	Fungal Infection
Chelladurai (6)	Infrared thermal camera	Linear discriminant analysis + Quadratic discriminant analysis	Fungal Infection
Jirsa (7)	Digital camera	Shape and color descriptor + Linear Discriminant Analysis	Fusarium

## References

- [1] Spector, D.L.; Goldman, R.D. (Eds.): *Basic Methods in Microscopy*. Cold Spring Harbor Laboratory Press, 2005.
- [2] FAO: *Global food losses and food waste – Extent, causes and prevention*. Rome, 2011.
- [3] Siripatrawan, U.; Makino, Y.; Kawagoe, Y.; Oshita, S.: *Rapid detection of Escherichia coli contamination in packaged fresh spinach using hyperspectral imaging*. In: *Talanta* 85 (2011) 1, pp 276-281.
- [4] Firrao, G.; Torelli, E.; Gobbi, E.; Raranciu, S.; Gianluca B.: *Prediction of milled maize fumonisin contamination by multispectral image analysis*. In: *Journal of Cereal Science* 52 (2010) 2, pp 327-330.
- [5] Kheiralipour, K.; Ahmadi, H.; Rajabipour, A.; Rafiee, S.; Javan-Nikkhah, M.: *Development of a new threshold based classification model for analyzing thermal imaging data to detect fungal infection of Pistachio Kernel*. In: *Agricultural Research* 2 (2013) 2, pp 127-131.
- [6] Chelladurai, V.; Jayas, D. S.; White, N.D.G.: *Thermal imaging for detecting fungal infection in stored wheat*. In: *Journal of Stored Products Research* 46 (2010), pp 174-146.
- [7] Jirsa, O.; Polisenka, I.: *Identification of Fusarium damaged wheat kernels using image analysis*. In: *Acta Universitatis Agriculturae Et Silviculturae Mendelianae Brunensis* 59 (2011) 5, pp 125-130.



### Muhammad Waseem Tahir, M.Sc.

Email: wtahir@imsas.uni-bremen.de  
Country: Pakistan  
Start: 01.10.2014  
Supervisor: Prof. Dr.-Ing. Walter Lang  
Faculty: Physics / Electrical Engineering  
Research Group: Institute for Microsensors, -actuators- and -systems (IMSAS)  
Funded by: German Academic Exchange Service (DAAD) and HEC



# Commercialization Challenges for Electric Vehicles in Urban Logistics

Molin Wang

**With deteriorating air quality and decreasing energy resources, Internal Combustion Engine (ICE) vehicles are experiencing a significant transition. Electric Commercial Vehicles (ECVs) are proposed as a feasible alternative. Urban Freight Transport (UFT) as a platform employing ICE vehicles is able to provide a chance to employ ECVs. However, the number of employed ECVs is lower than ICE vehicles and electric passenger cars. Therefore, this paper collects the characteristics of ECVs and the UFT by reviewing literatures to explain the employment problem. Moreover, the factors affecting the employment of ECVs are analyzed in the three pillars of sustainability with integrating technological dimension.**

**Introduction >>>** Internal combustion engine (ICE) vehicles are a main type of vehicles which are powered by burning fossil fuels. Based on the European Vehicle Market statistics data, ICE passenger cars accounted for 96% of total sales in 2013 [1]. This means that a large number of the greenhouse gases (GHG) such as CO<sub>2</sub> are being released by ICE vehicles. According to a forecasting by Mattila, that without additional policies the global GHG emissions will have increased by 90% until 2030 [2]. This will result in deterioration of the air quality and in additional global warming. Furthermore, oil shortage has become an obstacle of ICE vehicles. Based on a statistics data, the energy dependency ratio of the EU-28 has increased by 52.8% in 2011 [3]. Hence, fossil fuels will not be sufficient to provide primary fuels for vehicles in the future. Therefore, ICE vehicles are experiencing a significant transition.

ECVs are powered by electricity. They consist of batteries, electric machines, and transmission shafts [4]. However, because of long charging times, short driving ranges, and high battery costs, the acceptance of electric commercial vehicles is still in an initial stage. Moreover, the urban freight transport as an essential role in satisfying the needs of citizens, requires a large quantity of vehicles and sustainable development [5]-[6]. Low emission vehicles have become one of the recommended policy measures for the UFT [7]. Therefore, this paper collects the characteristics and factors of ECVs and the UFT to explain the employment problem. <<<

## Characteristics of ECVs

There are three categories of electric vehicles. They are: Battery Electric Vehicles (BEVs), Hybrid Electric Vehicles (HEVs), and Fuel Cell Vehicles (FCVs). For the HEV, depending on the type of refueling, there is another category called Plug-in Hybrid Electric Vehicles (PHEV) whose batteries are able to be charged by the electricity grid. This paper considers the four categories, summarizes the characteristics and illustrates them in table 1.

Firstly, a primary difference of categories is energy storage. BEVs generate electricity by batteries. HEVs and PHEVs are driven mainly by fossil fuels and partly by electricity. FCEVs have chemical reactions to generate electricity by fuel cells. Therefore, different energy storages lead to different characteristics. BEVs and FCEVs, since the chemical reaction generates the electricity to drive the vehicles, release zero emissions and do not rely on fossil fuels any more (if hydrogen is produced by alternative fuel). Moreover, they have a high energy efficiency because of employing electric motor drives. However, due to limited capacities and high cost of batteries and fuel cells, BEVs and FCEVs have a relatively short range and high initial costs compared to traditional vehicles. HEVs and PHEVs, since they keep ICE and batteries in the powertrain at the same time, the proportion of burning fuels has been reduced; the fuel efficiency has been improved. Furthermore, due to batteries and fuels coordinating with each other, the driving range is longer than that of BEVs and FCEVs. Nevertheless, HEVs and PHEVs are still depending on fossil fuels. The cost of hybrid electric vehicles is higher than traditional one because of the use of batteries.

The second difference of categories is the infrastructures. There are four type of refueling infrastructures - charging stations (BEVs), filling stations (HEVs), charging stations plus filling stations (PHEVs) and hydrogen filling stations (FCEVs). They represent different refueling times and refueling prices. For charging stations, the charging current decides the charging time. Based on the data from Mini E, the normal charging time takes 10.1 hours with a 12A charging current. The faster charging time is 2.4 hours with 50A charging current [8]. For filling stations, the refueling time is shorter than for charging stations, but the price of diesel or gasoline is 75%-80% higher than the electricity price. Likewise, for hydrogen filling stations, the refueling time is 5 minute, but the price is higher because of the complex refueling system of hydrogen.

Table 1 shows five examples of different ECVs. According to the displayed parameters, PHEVs have the longest driving range followed by FCEVs and BEVs. However, the payload of PHEVs is lighter than BEVs'.

## Characteristics of the UFT

The urban freight transport is a segment of freight transport, which takes place in an urban environment. There are five markets which cover the primary freight movements in cities. They are: retail markets, express/post markets, HoReCa (hotel, restaurant and catering)

markets, construction markets and waste markets. This paper summarizes their characteristics in table 2.

The retail market contains retail chains, independent retails and e-commerce. Retail chains are groups which distribute goods to their stores with their own account vehicles. In order to increase the efficiency in delivery, the retail chains tend to employ larger vehicles, but there are vehicle weight restrictions in urban areas. On the other hand, independent retailers are provided goods by wholesalers or suppliers. They do not pay for the transport directly. Therefore, independent retailers have more delivery times and diverse suppliers. E-commerce is an emerging market. It has a close connection to the express market. E-commerce requires a high amount of frequent deliveries. Express companies, which have a high quality and provide fast services, will support e-commerce to distribute goods to 70-90 receivers per delivery tour. In contrast, because of short networks and planning, a traditional parcel operator serves 20 receivers per delivery tour.

The HoReCa is a term to represent a market which provides food to hotels, bars, restaurants and catering. In order to keep the food fresh, just in time deliveries have become one characteristic of the market. Similar to the retail market, the HoReCa is divided into HoReCa chains and independent HoReCa respectively. HoReCa chains has less frequent deliveries and costs than the independent one, since it is a centralized procurement.

**Table 1:** Characteristics and examples of different electric vehicles

Categories of electric vehicles	Characteristics [9]	Examples
<b>BEV:</b> Propulsion – Electric motor drives Energy storage – Battery; Super capacitor Infrastructure – Charging stations	<ul style="list-style-type: none"> <li>– Zero local emissions</li> <li>– High energy efficiency</li> <li>– Independent of fossil fuels</li> <li>– Relatively short range</li> <li>– High initial cost</li> </ul>	IVECO electric daily (3.5t) [10] Payload: 1327kg Top speed: 70km/h Range: 90-130km Electricity consumption: 20-25 kWh/100km Electricity price: 0.297€/kWh
<b>HEV:</b> Propulsion – Electric motor drives; Internal combustion engines Energy storage – Battery; Super capacitor; Fossil or alternative fuels Infrastructure – Gasoline stations	<ul style="list-style-type: none"> <li>– Low local emissions</li> <li>– High fuel efficiency</li> <li>– Dependent on fossil fuels</li> <li>– Long driving range</li> <li>– Higher cost than ICE vehicles</li> </ul>	IVECO Daily Hybrid (3.5t) FUSO Canter Eco Hybrid (7.5t)
<b>PHEV:</b> Propulsion – Electric motor drives; Internal combustion engines Energy storage – Battery; Super capacitor; Fossil or alternative fuels Infrastructure-- Gasoline stations; Charging stations	<ul style="list-style-type: none"> <li>– Low local emissions</li> <li>– High fuel efficiency</li> <li>– Dependent on fossil fuels</li> <li>– Long driving range</li> <li>– Higher cost than ICE vehicles</li> </ul>	Via motors (3.9t) [11] Payload: 1270kg Range: 627.64km All electricity range: 56,327km Extended range: 563,27km Diesel price: 1.25 €/liter Gasoline price: 1.42€/liter
<b>FCEV:</b> Propulsion – Electric motor drives Energy storage – Hydrogen tank Infrastructure – Hydrogen filling stations	Hydrogen is produced by alternative fuel: <ul style="list-style-type: none"> <li>– Zero local emissions</li> <li>– High energy efficiency</li> <li>– Independent of fossil fuels</li> <li>– Relatively short range</li> <li>– High cost</li> </ul>	Fuel-cell Sprinter Mercedes Benz (3.5t) [12] Top speed: 131,97 km/h Range: 249,45km with 5,6kg hydrogen

The construction market delivers a wide range of materials to construction sites in the city, but because of project designing and planning problems, there are long waiting times to gain access to construction sites or for unloading. Moreover, the construction sites generate a large amount of waste which has to be removed by trucks.

The waste market is an important segment in the UFT. It collects municipal wastes like household wastes, commercial wastes and industrial wastes. Furthermore, because of fixed destinations, the waste collection routes are also relatively fixed.

### Analysis of factors

This paper classified the factors affecting the employment into three pillars of sustainability (economic, environmental and social) with integrating technological dimension.

Concerning the economic factor, high investment costs are a critical obstacle to employ ECVs in the UFT. It contains the purchase price of ECVs and the construction costs of infrastructures. According to the above characteristics of EVs, batteries are the main reason for the high purchase price. Additionally, when a logistics company will change a fleet of ICE vehicles to a fleet of ECVs, they will construct additional charging stations instead of using public filling stations. Furthermore, the maintenance costs are a barrier because of battery costs and the lack of a complete maintenance network. In contrast, the low electricity costs are an element to attract customers, when it is compared to the high lifetime fuel costs of traditional vehicles.

The environmental factor is a positive factor to promote development and commercialization of ECVs. The emissions, the noise and the general shortage of energy resources are triggers to research and develop electric vehicles. Furthermore, batteries of EVs are able to be recycled and reused in other facilities.

For the social factor, the social exposure is a way to advertise ECVs, because it includes marketing and word of mouth to improve the awareness and spread the knowledge [14]. Moreover traffic congestions resulting from driver behavior, inefficient operations and long idling times impact on the parameters of ECVs.

Concerning the technological factor, a short driving range is a reason to prevent the commercialization of ECVs. It is due to the limited battery capacity. In addition, battery weights have influence on the payload of ECVs. On the other hand, load factor, empty running and times of delivery affect the efficiency in the urban freight transport. Information and communication technology (ICT) is a method to solve the problem. Furthermore, the brake energy regeneration system of ECVs is able to improve the driving range.

Figure 1 summarizes and illustrates a framework of this research. There are five markets of the UFT and four categories of ECVs. The three stakeholders have some overlapping sections which means some of the suppliers and receivers have the same function as the carriers. The objective of this research is to employ ECVs in the carriers section with the influence from the factors.

**Table 2:** Characteristics of the UFT markets [13]

UFT markets		Characteristics
Retail	Retail chains	Use own account vehicles Larger vehicles
	Independent retail	More delivery times Diverse suppliers
	E-commerce	High amount and frequency deliveries Low size of a single delivery
Express/post		Express company: 70–90 receivers per delivery tour Parcel operators: 20 receivers per delivery tour
Hotel, restaurant and catering (HoReCa)		Just in time deliveries Independent HoReCa: frequent deliveries HoReCa chains: centralized procurement and less frequent deliveries
Construction		A wide range of material High proportion of lorries either empty or with part-loads Long waiting time to gain access in construction sites and to unload Remove significant amount of waste
Waste		Many different type of wastes Fixed collection routes

**Figure 1:** Framework of the research

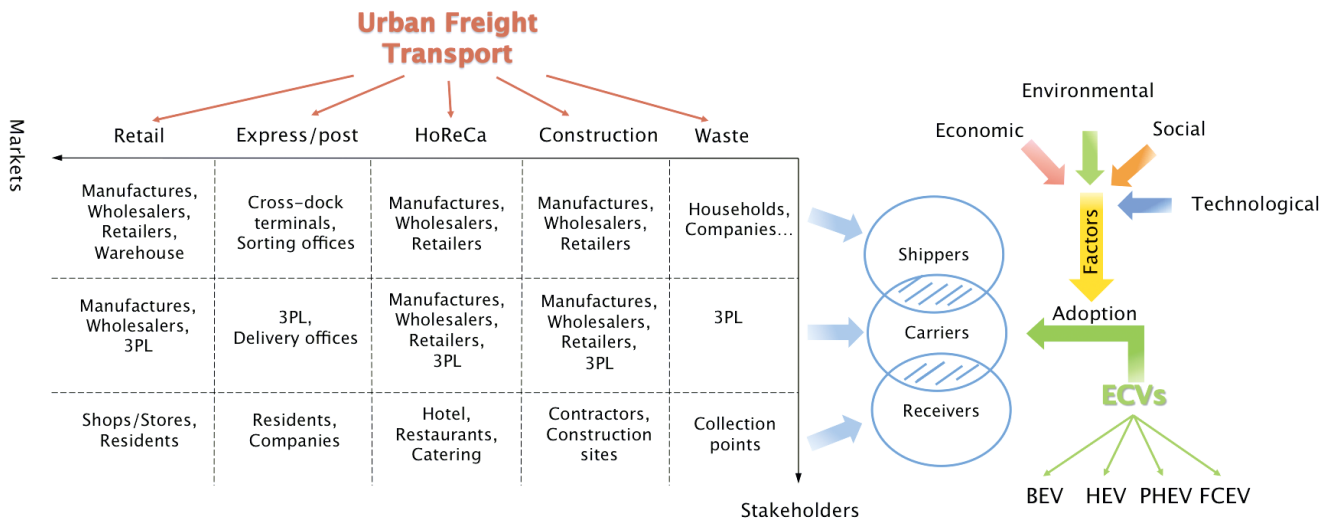

## Conclusion

The paper collects the characteristics of ECVs and the UFT by reviewing the literature. Moreover, it analyzes the factors with the three pillars of sustainability and technological dimension. Finally, the paper develops a framework to describe the whole idea. The future work of the research is to design a questionnaire to rank the factors and find an optimal combination between different categories of ECVs and different markets of the UFT.

## References

- [1] The international council on clean transportation: European vehicle market statistics pocketbook, 2014.
- [2] Mattila, T.; Antikainen, R.: Backcasting sustainable freight transport systems for Europe in 2050. In: *Energy Policy* 39 (2011), pp 1241-1248.
- [3] Euro Union: *Energy, transport and environment indicators*. Luxembourg, 2013.
- [4] Chan, C. C.: *The State of the Art of Electric and Hybrid Vehicles*. In: *Proceedings of the IEEE* 90 (2002) 2, pp 247-275.
- [5] The American Recovery and Reinvestment Act of 2009, 2009. Public Law. 111-5, Congress.
- [6] Peterson; S.B.; Michalek, J.J.: Cost-effectiveness of plug-in hybrid electric vehicle battery capacity and charging infrastructure investment for reducing US gasoline consumption. In: *Energy Policy* 52 (2013), pp 429-438.
- [7] The international council on clean transportation: *EU CO2 emission standards for passenger cars and light-commercial vehicles*, January 2014.
- [8] Mini E pilot project: *Daten&Ausstattung*. URL: [http://www.mini.de/minimalism/product/mini\\_el](http://www.mini.de/minimalism/product/mini_el), Date of access 01.09.2015.
- [9] Chan, C. C.: *Electric, Hybrid, and Fuel-Cell Vehicles: Architectures and Modeling*. In: *IEEE Transactions on Vehicular Technology* 59 (2010) 2, pp 589-598.
- [10] Iveco: *The electric new daily*. URL: <http://www.iveco.com/en-us/press-room/kit/Pages/4-INTERMATDailyelet.aspx>, Date of access 01.09.2015.
- [11] Via Motors: *The Worlds First Extended-Range Electric Vans*. URL: <http://www.viamotors.com/vehicles/electric-van/>, Date of access 01.09.2015.
- [12] McBride, J.; Wysor, T.; Tran, D.; Cherry, J.; Danyko, D.; Hall, R.; Schamm, R.; Wolfsteiner, M.; Friedrich, J.: *Fuel Cell Package Delivery Vehicle Testing Program*. In: 2006 Fuel Cell Seminar. Honolulu, Hawaii 2006.
- [13] MDS Transmodal Limited: *Study on Urban Freight Transport – Final Report*, April 2012.
- [14] Struben, Jeroen J.R.: *Essays on transition challenge for alternative propulsion vehicles and transportation system*. MIT, 2006.

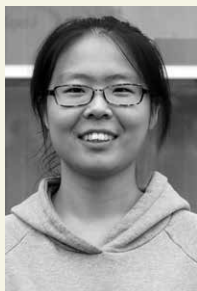

**Molin Wang, M.Sc.**

Email: wag@biba.uni-bremen.de  
 Country: China  
 Start: 01.10.2013  
 Supervisor: Prof. Dr.-Ing. Klaus-Dieter Thoben  
 Faculty: Production Engineering  
 Research Group: Collaborative Business in Enterprise Networks  
 Funded by: China Scholarship Council (CSC)

# An Idea of 3D Printed GC Column in Gas Chromatographic Systems

Nayyer Abbas Zaidi

Using the silicon fabricated Gas Chromatographic (GC) column requires complex housing and hot metal plate for the operation in the GC system. Making this complex housing for different GC columns and sealing them is tedious and time consuming also the use of metal plate does not provide an appropriate heat gradient inside the GC column. In this report, a novel idea of 3D printed GC column fabricated in 3D printer which is embedded with heating system in a single unit is presented. The design of the 3D printed column is modeled in Inventor 2015 software.

**Introduction >>>** In fruit logistic industries the sensors inside the containers that can predict the shelf life of the fruits are of great interest. These sensors include the temperature, humidity, oxygen and carbon dioxide. However, these sensors are not enough when the situation comes to the climacteric fruit like bananas that respire in the container consuming the oxygen and producing the carbon dioxide and ethylene. In an unripe state the amount of ethylene is in few  $\mu\text{l}/\text{kg}\cdot\text{h}$  but in the ripe state this is folded by 10 or more [1]. As the amount of ethylene accumulates in the container it acts as an accelerator which accelerates the ripeness of other fruits in the container. Presently the process of ventilation is used to reduce the ethylene gas, however, such sensors are required that can detect the ethylene in the level of parts per billion in volume [2].

In recent literature there are several methods proposed for the detection of ethylene gas. The most common and ready and easy to used methods are Portable electronic Nose (PEN) and Electronic Olfactory System (EOS<sup>835</sup>), which consists of array of metal oxide sensors. These electronic noses not only detect the ethylene, but also the sensor arrays inside it that can detect the fungal or bacterial diseases [3-6]. The problems with these electronic noses are they are very expensive, insensitive especially when the amount of ethylene is measured in parts per billion by volume (PPBv). Another method used for the detection of Ethylene gas is Non-Dispersive-Infrared (NDIR). This system consists of a chamber, an Infrared source and detector. To increase the sensitivity of the system scientists have placed Pre-concentrator. Passive sensitivity improvements like shape of the chamber spherical, rectangular and triangular and polishing it with silver coating to make the surface

as reflective as possible to avoid the reflection losses are presented in [7-8]. However, with these improvement makes the system expensive and still unable to meet the requirement required for the ethylene detection in intelligent container.

Another traditional method for the detection of ethylene in an intelligent container is Gas Chromatography. The main components used in the Gas Chromatographic system are miniaturized Gas Chromatographic column, a miniaturized Preconcentrator PC and a nonselective ethylene gas detector. However, there are several challenges involved in the use of this GC system practically inside the container. One challenge is the silicon fabricated GC column that requires complex housing to connect it with the gas tubes and hot plate that can provide the temperature in the range of 30 – 65°C. In this report, an idea of 3-D printed gas chromatographic column in which heater is embedded inside it, is presented for the measurement of ethylene gas inside the intelligent container.

<<<

## Working principle of GC system

The developed GC system for the measurement of ethylene consists of GC column, Pre-concentrator, Gas sensor and four valves as shown in Fig. 1. The four valves V1 to V4 are used to direct the flow of carrier gas into the PC and GC or bypass them. The carrier gas in our case is synthetic air that continuously flows inside the GC system. In the first step, the concentration of ethylene in sample air is introduced to the PC in which the ethylene molecules are

trapped in it. This process is called adsorption and the PC is kept at room temperature. This requires approximately 25 min. After that, carrier gas is used that bypass the PC and goes to GC in order to flush out or clean the pneumatic channels and the GC column. A good base line or reference line can be seen in the Labview through National instrument DAC card which is used to interface the sensor to the Computer. After getting the base line, the PC is heated to 250°C for 10min. While heating the molecules detached from the stationary phase, then the Carrier gas now flows in the PC using the valves and takes the detached ethylene molecules into GC, where separation starts. The non-selective gas sensor gives different peaks for different gases.

**Figure 1:** Schematic diagram of GC-system

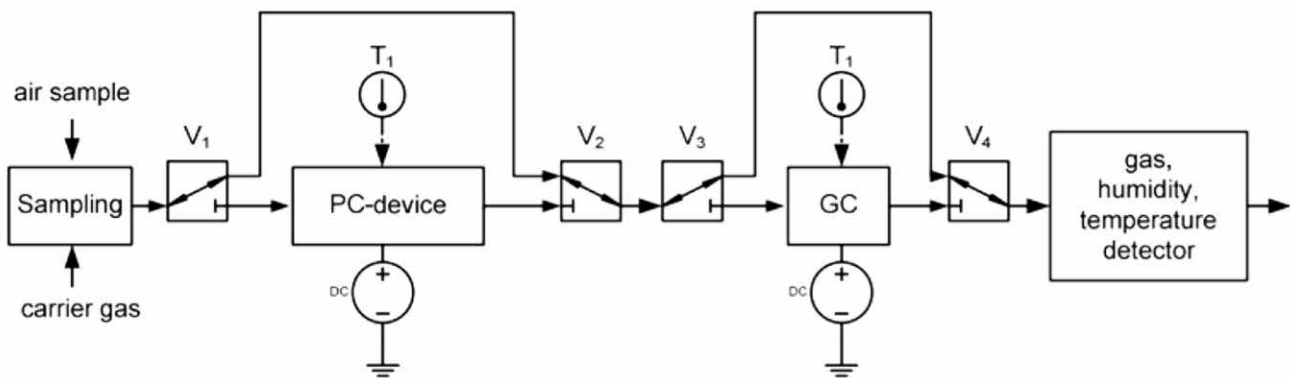

## References

- [1] Sklorz, A.; Schu, A.; Nießen, M.; Janßen, S.; Lang, W.: Humidity Influence in Application of  $\mu$ GC-Systems for Ethylene Gas with Preconcentrator Devices and SnO<sub>2</sub> Based Detectors. In: IEEE SENSORS Conference. Limerick, Ireland 2011, pp 1085 - 1088.
- [2] Janßen, S.; Tessmann, T.; Lang, W.: High Sensitive and Selective Ethylene Measurement by Using a Large capacity-on-chip Preconcentrator Device. In: Sensors and Actuators B: Chemical 197 (2014) 5, pp 405-413.
- [3] Baietto, M.; Wilson, A.D.; Bassi, D.; Ferrini, F.: Evaluation of Three Electronic Noses for Detecting Incipient Wood Decay. In: Sensors 10 (2010) 2, pp 1062-1092.
- [4] Spinelli, F.; Noferini, M.; Vanneste, J. L.; Costa, G.: Potential of the Electronic-Nose for the Diagnosis of Bacterial and Fungal Diseases in Fruit Trees. In: EPPO Bulletin 40 (2010) 1, pp 59-67.
- [5] Berna, A.: Metal Oxide Sensors for Electronic Noses and Their Application to Food Analysis. In: Sensors 10 (2010) 4, pp 3882-3910.
- [6] Pan, L.; Zhang, W.; Zhu, N.; Mao, S.; Tu, K.: Early Detection and Classification of Pathogenic Fungal Disease in Post-Harvest Strawberry Fruit by Electronic Nose and Gas Chromatography-Mass Spectrometry. In: Food Research International 62 (2014), pp 162-168.
- [7] Hodgkinson, J.; Smith, R.; Ho, W.O.; Saffell, J.R.; Tatam, R.P.: Non-dispersive infra-red (NDIR) Measurement of Carbondioxide at 4.2 $\mu$ m in a Compact and Optically Efficient Sensor. In: Sensor and Actuator B: Chemical 186 (2013), pp 580-588.
- [8] Sklorz, A.; Janßen, S.; Lang, W.: Detection Limit Improvement for NDIR Ethylene Gas Detectors using Passive Approaches. In: Sensors and Actuators B: Chemical 175 (2012), pp 246-254.



### Nayyer Abbas Zaidi, M.Sc.

Email: nzaidi@imsas.uni-bremen.de  
Country: Pakistan  
Start: 01.10.2014  
Supervisor: Prof. Dr.-Ing. Walter Lang  
Faculty: Physics / Electrical Engineering  
Research Group: Institute for Microsensors, -actuators- and -systems (IMSAS)  
Funded by: German Academic Exchange Service (DAAD) and HEC

# Modeling the Processes of the Mining Industry Using SCOR and DCOR models

Raúl Zuñiga Arriaza

The mining industry is essential for manufacturing as it provides the basic materials for the value adding processes. However, a thorough integration of the mining industry within the supply chain is still an exception. This industry and its processes of exploration, engineering design, construction, extraction, processing, and distribution differs from the average manufacturing company's processes. The objective of this paper is to develop a process model as an adaptation of the Supply Chain Operations Reference (SCOR) model and the Design Chain Operations Reference (DCOR) model to describe the mining processes. These adapted models allow describing supply chains and design chains respectively, using their own standard main processes. This paper thus demonstrates that the mining processes can be described using the adapted SCOR and DCOR models. This work concludes that the adapted SCOR and DCOR model allows to select and use Key Performance Indicators (KPIs) and Best Practices to improve transparency in the mining processes.

**Introduction >>>** Entering the age of supply chain competition [1], as of today, several industries have implemented supply chain models and frameworks describing supply chain processes in order to increase the understanding and transparency between partners. One of the most successful and most deployed frameworks is the SCOR model [2], a framework created by the Supply Chain Council [3]. This SCOR model was originally designed to fit the requirements on modeling the processes within a manufacturing environment. Hence, the manufacturing and the related processes were extensively studied and there is a wide selection of literature on the topic of describing various successful applications of the SCOR model within the manufacturing industry [4,5,6,7].

However, looking at the very beginning of a supply chain, i.e. the mining industry, it becomes evident that little research been conducted on describing the inherent processes of this industry following the SCOR and DCOR models [8]. A better understanding of the complexity and characteristics of the processes differing most from the average manufacturing process can contribute to improve the entire supply chain performance. In this context, the key issue is to increase the understanding and the transparency for the following stakeholders. Supply chain integration in the mining industry can help to optimize the total supply chain performance rather than optimizing its inherent parts, resulting in a better overall outcome [9]. <<<

Figure 1: Processes of the mining industry (adapted from EMMMV [10])

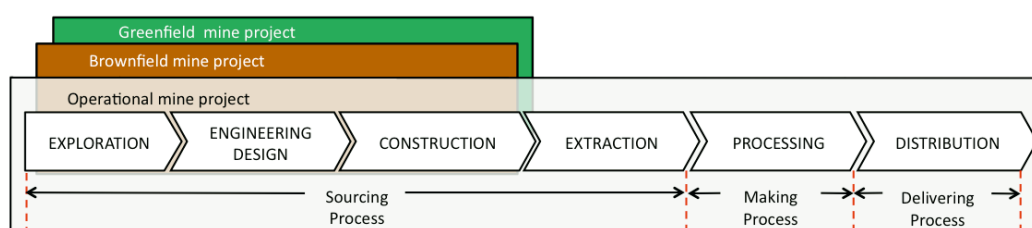

## Description of the EM model, SCOR and DCOR models

For describing the processes of the mining industry by using the supply chain concepts, it is necessary to study the Exploration and Mining Business Reference Model (EM-model). After that, the challenge is to adapt the processes of the SCOR model and the DCOR model in order to describe the mining processes of the EM model. This section describes these models.

Figure 1 shows the processes of the EM-model. This model is an industry business process model providing a categorization of activities applicable to the mineral raw materials industry [10]. The EM-model provides a definition and description of the mining processes. However, this model does not include information on key performance indicators (KPIs) and best practices for the mining industry. In addition, this model does not use a standard, generic, and compatible language, which can be accepted in the entire supply chain. The EM-model is a model for the mining industry, which differs from the standard SCOR, and DCOR models. Hence, the processes of EM-model require to be described by using the SCOR and DCOR models to contribute to the improvement of the integration and visibility of these processes in the entire supply chain.

The SCOR model has been widely used in recent years to analyze and reconfigure operations in the supply chain context. Several of these research works focus on the SCOR model application to different industrial environments. Examples of these applications are Services [2], Geographic Information Systems [11], Military [12],

Manufacturing [7], and Construction [13]. However, the mining industry and its processes present many atypical characteristics, which are challenging to comply with the existing SCOR model framework, and only very little research has covered this early part of the supply chain. The version 10.0 of SCOR model includes a framework for business processes, metrics, best practices, and people [3]. SCOR describes a supply chain as consisting of five primary management processes; Plan, Source, Make, Deliver and Return. These processes are Level 1 processes within the SCOR hierarchy.

The DCOR model defines the business activities between customer requirements and the design or specification of a product to meet customer demand. The purpose of DCOR is to standardize the definition of product development and R&D, particularly for New Product Development (NPD) processes for offering a common language among design chain partners. DCOR identifies the metrics used to manage these processes. The model itself contains several sections and is organized around the five primary processes: Plan, Research, Design, Integrate and Amend. This model borrows heavily from SCOR in terms of language, presentation and layout. Similarly, to SCOR, the DCOR model includes performance attributes, best practices and metrics [14]. The model has been designed and maintained to support design chains of various complexities and across multiple companies. Every organization using the DCOR model to improve its design chain needs to extend the model, at least to Level 4, by using organization-specific processes, systems, and practice [15].

**Figure 2:** The extraction process in mining industry

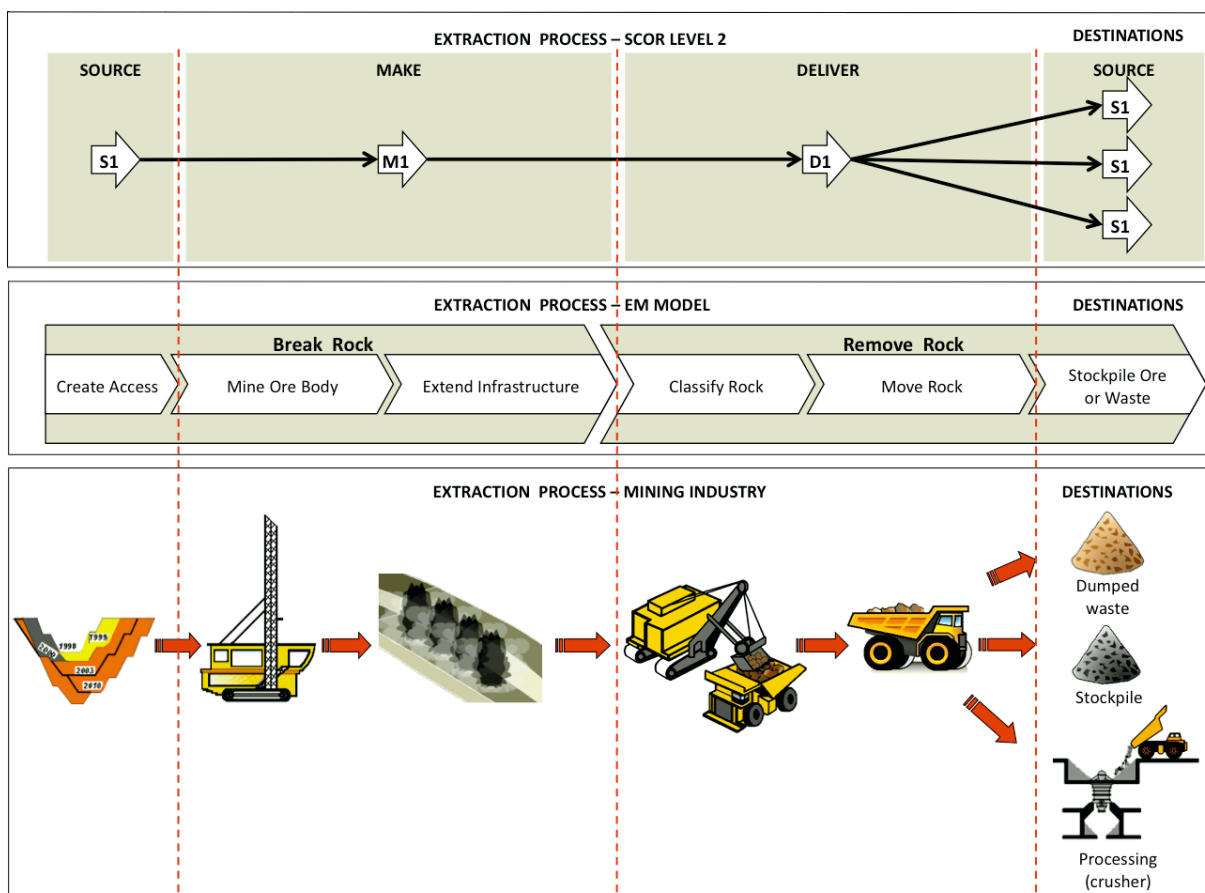



### Transforming the EM-Model into the SCOR Level 2 model in the extraction process

Because the EM model does not use a standard, generic, and compatible language which can be accepted in the entire supply chain, it is required to transform these processes into the SCOR Level 2 model to extraction process. The analysis starts with the definitions and descriptions of this process using the reference model proposed by EMMMV [10]. This model defines the extraction process as follows: "For a given mine type, rock type, and mining type, this process includes the breaking and removal of ,rock'. Figure 2 shows the extraction process. Rock is a generic term used to describe all types of mineral resource host material. It also includes the transport of the broken rock and waste material from the working place to the plant and/or stockpile." The extraction process includes two levels of lower processes, the "Break Rock" and the "Remove Rock".

Figure 3 shows the SCOR Level 2 model for a supply chain of the extraction process in the mining industry. This SCOR Level 2 model can be analyzed starting from the construction process (the supplier). The construction process delivers a stock of mineral blocks (process element D3). The extraction process includes the SCOR processes S1, M1, and D1. These processes are explained as follows [16, 17]:

Source stocked product (S1). This process manages the stock of mineral blocks, in other words, the raw materials for the extraction process. This stock of mineral blocks represents the mineral resource inventory of a mine project. The extraction process has access to this stock of blocks when the construction process has both developed the mine and delivered the stock of blocks (process element D3). The viable blocks are then transferred (assigned) within the extraction process according to the sourcing plan 'P2'.

That way, the extraction process has a certain amount of available blocks in the mineral resource inventory for product manufacture (mineral rock).

Make-to-stock (M1). The product of this process is the mineral rock, the rock of a low ore grade, and the waste material (sterile). In this case, M1 is a plan-driven process as mineral rock is generally produced in accordance with a planned schedule following production plan 'P3'. In the context of the extraction process, this process includes the test of the product in order to classify the ore grade in the rocks and the sterile material. These materials are stored on a stockpile (transiently), in an open place located in the place where they are produced, before being delivered to a predefined destination.

Deliver stocked product (D1). This represents the process of delivering the product which, in this case, is made based on two things: planned demand of the processing plant, and inventory re-ordering parameters according to the production plan requirements. D1 is the 'remove rock' process depicted in Figure 2. Additionally, this process includes all activities involved in the delivery process of a product from storage to the predefined destinations (processing plant, stockpile, dumped waste) via a transport system. The intention of delivering stocked product is to have the mineral rock available to prevent the processing plant from stopping due to lack of raw material. The D1 process delivers mineral rocks according to the delivering plan 'P4'. The source stocked product (S1) of the processing plant then receives the mineral rock from the extraction process and transfers it to the processing plant. Thus, the processing plant has the mineral rock for product manufacture (e.g. copper concentrate, copper cathodes) according to the production plan.

**Figure 3:** The extraction process using SCOR Level 2 model

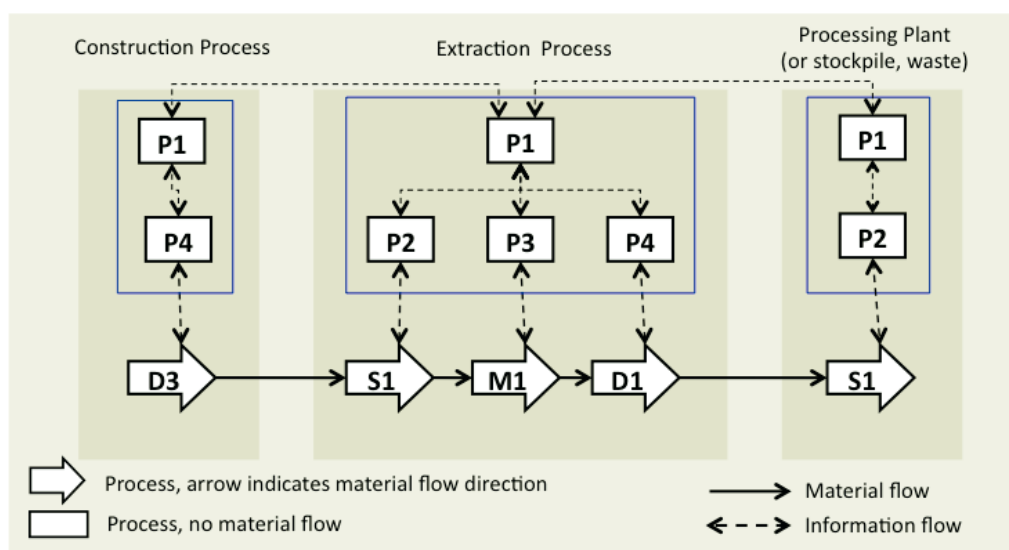

**Figure 4:** Adapted DCOR Level 3 model

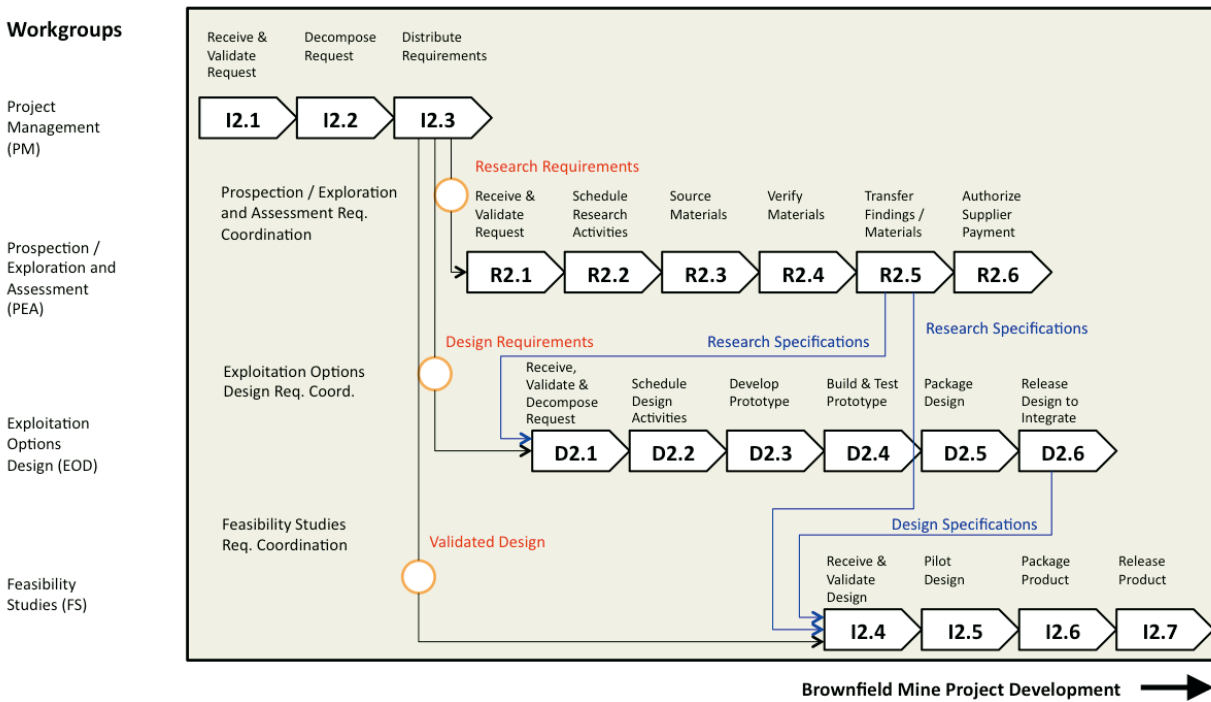

## Transforming the EM-Model into DCOR Level 3 model in the exploration process

Figure 4 shows the adapted DCOR Level 3 model to describe the exploration process for a Brownfield Mine Project. Four workgroups are involved in the development of a Brownfield Mine Project. These workgroups are Project Management (PM), Prospection/Exploration and Assessment (PEA), Exploitation Options Design (EOD), and Feasibility Studies (FS).

A mining company can first designate the names of workgroups from Project Management to Feasibility Studies on the Y-axis (Step 1). Next, by mapping the process elements of DCOR (depicted in Figure 4) to work groups' tasks, process elements I2.1–I2.3, R2.1–R2.6, D2.1–D2.6, and I2.4–I2.7 are assigned to workgroups PM, PEA, EOD, and FS, respectively. Afterwards, the input/output information vertically flowing among workgroups is retrieved from DCOR and depicted on the diagram to connect relevant process elements (Step 2). As Figure 4 shows, there are six cross-workgroup information flows, which indicate a likely place for cooperation-activities. However, three early cooperation-activities, including Prospection/Exploration and Assessment Requirements Coordination, Exploitation Options Design Requirements Coordination, and Feasibility Study Requirements Coordination, are finally specified on the diagram (Step 3) and the desired Development process of a Brownfield Mine Project is derived. It is mainly charged with receiving, decomposing, and distributing requirements.

For example, workgroup PM initiates the development process with customer requirements (e.g. customers can be owners, stakeholders). The tasks for PM are represented by the process elements I2.1–I2.3 that are shown in Figure 4. PM works with the Prospection / Exploration and Assessment (PEA) to reach a consensus on customer requirements (research requirements). After, based on requirements, PEA identifies and decomposes the research topics to locate

the presence of economic mineral deposits. The tasks for PEA are represented by the process elements R2.1–R2.6 which are shown in Figure 4. When PEA gets a potential mineral deposit, the results on research specifications are delivered. These results provide the geological and mineralogical data with spatial attributes and a geological model for the next workgroup (EOD). The workgroup EOD can use this information as a basis for planning and mine design. In the same way the other groups are analyzed until the workgroup FS releases the project definition and documentation in order to make a go / no-go decision.

## Conclusion

This paper demonstrates how the SCOR and DCOR models may be adapted in order to model the extraction process and the exploration process respectively. This implies that the SCOR and DCOR models allow modeling a crucial part of the mining processes within the mining industry – without any need to integrate other generic processes into the existing SCOR and DCOR models. The exploration and extraction processes are relevant because as they represent the processes that support the supplying of the raw materials required by the production plant in the mining industry. Any variations in performance and efficiency for these processes may influence the downstream processes.

In addition, it can be concluded that there is a potential integration between the processes of the early part of the supply chain in the mining industry with the other processes in the supply chain using SCOR and DCOR models. Additionally, the use of the Key Performance Indicators (KPIs) and Best Practices validated throughout the supply chain contributes to improving transparency in the mining industry's processes. This is supported by the use of the SCOR and DCOR models.

## References

- [1] Christopher, M.: *Logistics and Supply Chain Management – Creating Value-Adding Networks*. FT Prentice Hall, Harlow 2005.
- [2] Barnard, J.: *A Multi-View Framework for Defining the Services Supply Chain Using Object Oriented Methodology*. University of Central Florida, Orlando, USA 2006.
- [3] Supply Chain Council: *Supply Chain Operations Reference Model SCOR Version 10.0. The Supply Chain Reference ISBN 0-615-20259-4 (binder)*, 2010.
- [4] Hwang, Y.; Lin, Y. C.; Jung, L. J.: *The Performance Evaluation of SCOR Sourcing Process: The Case Study of Taiwan's TFT-LCD Industry*. In: *International Journal of Production Economics* 115 (2008) 2, pp 411-423.
- [5] Hau, L. L.; Chung-Yee, L.: *Building Supply Chain Excellence in Emerging Economies*. In: *International Series in Operations Research & Management Science* 98. Springer US, 2007.
- [6] Vanany, I.; Suwignjo, P.; Yulianto, D.: *Design of Supply Chain Performance Measurement System for Lamp Industry*. In: *1st International Conference on Operations and Supply Chain Management*. Bali, Indonesia 2005.
- [7] Fronia, P.; Wriggers, F. S.; Nyhuis, P.: *A Framework for Supply Chain Design*. In: *EngOpt 2008-International Conference on Engineering Optimization*. Rio de Janeiro, Brazil 2008.
- [8] Tardelli, P.; Barbin, F.; Cesare de Tomi, G.: *ERP in Mining Industry: Studying the Software Functionality and the Value Chain*. In: *Second World Conference on POM and 15th Annual POM Conference*. Cancun, Mexico 2004.
- [9] Accenture: *How Do Mining Companies Achieve High Performance Through Their Supply Chains?*, 2007. URL: [http://www.accenture.com/au-en/Documents/PDF/Mining\\_Supply\\_Chain.pdf](http://www.accenture.com/au-en/Documents/PDF/Mining_Supply_Chain.pdf), Date of access 04.01.2013.
- [10] EMMMV: *The Exploration and Mining Business Reference Model*, 2010. URL: [https://www.opengroup.org/emmmv/uploads/40/22706/Getting\\_started\\_with\\_the\\_EM\\_Business\\_Model\\_v\\_01.00.pdf](https://www.opengroup.org/emmmv/uploads/40/22706/Getting_started_with_the_EM_Business_Model_v_01.00.pdf), Date of access 05.01.2014.
- [11] Schmitz, P. M.: *The Use of Supply Chains and Supply Chain Management to Improve the Efficiency and Effectiveness of GIS Units*. Ph.D. thesis, University of Johannesburg, South Africa 2007.
- [12] Bean, W. L.; Schmitz, P. M.; Engelbrecht, G.: *Adapting the SCOR Model to Suit the Military: A South African Example*. In: *Proceedings of the 14th Annual Logistics Research Network Conference: Volatile and Fragile Supply Chains*. Cardiff, UK 2009.
- [13] Cheng, J.; Law, K.; Bjornsson, H.; Jones, A.; Sriram, R. D.: *Modeling and Monitoring of Construction Supply Chains*. In: *Journal Advanced Engineering Informatics* 24 (2010) 4, pp 435-455.
- [14] Supply Chain Council: *Design Chain Operations Reference-Model (DCOR) Version 1.0*. Supply-Chain Council, Pennsylvania 2006.
- [15] Lyu, J.; Chang, L.; Cheng, C.; Lin, C.: *A Case Study Approach on the Development of Design Chain Operations Reference-Model*. In: *The Mold Industry*. In: *International Journal of Electronic Business Management* 4 (2006) 2, pp 113-122.
- [16] Zuñiga, R.; Wuest, T.; Thoben, K. D.: *Comparing mining and manufacturing supply chain processes: challenges and requirements*. In: *Production Planning & Control: The Management of Operations*. Taylor & Francis, 2013.
- [17] Zuñiga, R.; Seifert, M.; Thoben, K. D.: *Study on the Application of DCOR and SCOR Models for the Sourcing Process in the Mineral Raw Material Industry Supply Chain*. In: *Proceedings of the 3rd International Conference on Dynamics in Logistics (LDIC 2012)*. Bremen, Germany 2012, pp 211-221.
- [18] Juan, Y. C.; Ou-Yang, C.; Lin, J. S.: *A Process-Oriented Multi-Agent System Development Approach to Support the Cooperation-Activities of Concurrent New Product Development*. In: *Computers & Industrial Engineering* 57 (2009), pp 1363-1376.



Raúl Zuñiga Arriaza, M.Sc.

Email: zun@biba.uni-bremen.de  
 Country: Chile  
 Start: 05.05.2009  
 Supervisor: Prof. Dr.-Ing. Klaus-Dieter Thoben  
 Faculty: Production Engineering  
 Research Group: Collaborative Business in Enterprise Networks  
 Funded by: Universidad Arturo Prat, Chile



## Imprint

### **LogDynamics Research Report**

ISSN 1867-0210

Volume 4, 2015

Research Report 2014/15

International Graduate School for Dynamics in Logistics (IGS)

### Statutory Declaration

All rights reserved. No part of this publication may be reproduced, stored in a retrieval system, or transmitted in any form or by any means, mechanical, electronic, photocopying, recording, or otherwise, without prior written permission of LogDynamics.

### Place of Publication

Bremen, Germany

### Publisher

Bremen Research Cluster for Dynamics in Logistics (LogDynamics)  
Universität Bremen

### Responsible

Prof. Dr. rer. pol. Hans-Dietrich Haasis (IGS)

Prof. Dr.-Ing. habil. Klaus-Dieter Thoben (LogDynamics)

The sole responsibility for the content of the named articles lies with the authors.

### Editors

Dr.-Ing. Ingrid Rügge

Indah Lengkong

### Contact

IGS, Universität Bremen

Dr.-Ing. Ingrid Rügge

c/o BIBA

Hochschulring 20

28359 Bremen, Germany

Phone: +49 421 218 50139

Fax: +49 421 218 50031

Email: [info@IGS.LogDynamics.de](mailto:info@IGS.LogDynamics.de)

Internet: [www.LogDynamics.com](http://www.LogDynamics.com)

#### Design

Gudrun Feilcke, Grafik-Design

#### Picture Credits

LogDynamics, BIBA

Universität Bremen

Page 2: bremenports/BLG

Page 6: bremenports/BLG

#### Article

The article on page 39 is an excerpt of the paper: Akbar, MS.;Khan, MS.;Khaliq, KA.; Qayyum, A.;Yousaf, M.: Evaluation of IEEE 802.11n for multimedia applications in VANET, The 5th International Conference on Ambient Systems, Networks and Technologies (ANT-2014), Belgium, Volume 32, June-2014, pp 953–958.

The article on page 55 is an excerpt of the paper: T. Pötsch, S. N. K. Marwat, Y. Zaki, and C. Görg, "Influence of Future M2M Communication on the LTE System," in Proc. of 6th Joint IFIP Wireless and Mobile Networking Conference (WMNC), Dubai, United Arab Emirates, Apr. 23-25 2013.



# LogDynamics Summer School (LOGISS) 2016

## Control Interfaces in Logistics: Data and Algorithms

February 29 –  
March 4, 2016  
Bremen, Germany



### Contact

summerschool@logdynamics.de  
www.summerschool.logdynamics.de  
www.logdynamics.de

### Program

#### **Sunday, February 28, 2016**

Get-Together and Registration

#### **Monday, February 29, 2016**

Control Theoretic Modeling  
of Logistics Systems  
Prof. Neil Duffie, PhD  
University of Madison-Wisconsin, USA

#### **Tuesday, March 1, 2016**

Speed Dating & Excursion  
Dr.-Ing. Ingrid Rügge  
LogDynamics, University of Bremen, Germany

#### **Wednesday, March 2, 2016**

Industry 4.0  
Prof. Dr. Michael Henke  
Technical University of Dortmund, Germany

#### **Thursday, March 3, 2016**

Complex Networks in Logistics  
Dr. Olivia Woolley  
ETH Zurich, Switzerland

#### **Friday, March 4, 2016**

Process Analysis using Machine Learning  
Prof. Christopher Irgens, PhD  
University of Strathclyde, UK

### Organizers

#### **University of Bremen LogDynamics**

Prof. Dr. Tobias Buer  
Prof. Dr. Till Becker  
Prof. Dr. Jürgen Pannek





**Bremen Research Cluster for  
Dynamics in Logistics**

**International Graduate School  
for Dynamics in Logistics**

Universität Bremen  
Postfach 330 440  
28334 Bremen, Germany  
Email: [info@LogDynamics.com](mailto:info@LogDynamics.com)  
Internet: [www.LogDynamics.com](http://www.LogDynamics.com)

ISSN 1867-0210